

Functional Specification of the Instant Payment Service of the Electronic Clearing System of Latvijas Banka (EKS)

Version: APR2025~~OCT2025~~-1.00.5

Changes implemented on: 1-5 April~~October~~ 2025

Rīga

1.	Message and file exchange in the instant payment service	4
1.1.	File exchange using file exchange service	4
1.2.	Message and file exchange using message queues.....	4
1.3.	Configuration of queues	6
1.4.	Message and file signing	7
1.4.1.	Message signing	7
1.4.2.	File signing, if message queues are used for file exchange.....	9
2.	The format of messages and files, message routing	10
2.1.	The format to be used for generating messages	10
2.1.1.	Common format to be used for generating messages.....	10
2.1.2.	The format to be used for message identifiers.....	10
2.2.	Messages and routing	11
2.3.	Forwarding messages addressed to the participant's, that is a participant in TARGET, TIPS DCA account	13
2.4.	Files sent by the instant payment service	14
3.	Timetable of the instant payment service	15
3.1.	For the participant, that is a participant in TARGET	15
3.2.	For the participant, that is not a participant in TARGET	15
4.	Process flow of instant payment order processing	16
5.	Process flow of instant payment cancellation request, instant payment return order and instant payment resolution of investigation processing.....	23
6.	Generating messages	26
6.1.	Instant payment message (pacs.008.001.08)	26
6.2.	Instant payment return message (pacs.004.001.09).....	37
6.3.	Instant payment status message (pacs.002.001.10).....	44
6.4.	Instant payment cancellation request message (camt.056.001.08).....	51
6.5.	Instant payment resolution of investigation message (camt.029.001.09).....	57
6.6.	Instant payment status request message (pacs.028.001.03).....	63
6.7.	Reply message to an incoming message not compliant with the scheme	67
6.8.	Technical maintenance message.....	68
6.9.	Double-entry check.....	69
7.	Management of instant payment liquidity position	70
7.1.	Current IP liquidity position request message (camt.060)	70
7.2.	Liquidity transfer order to increase current IP liquidity position sent by the participant that is a participant in TARGET.....	70
7.3.	Payment to increase the IP liquidity position sent by the participant that is not a participant in TARGET	71
7.4.	Liquidity transfer order to decrease current IP liquidity position	71
7.5.	Notification of rejection of liquidity transfer order to increase/decrease current IP liquidity position	71
7.6.	Current IP liquidity position message (camt.052).....	71
7.7.	IP liquidity position credit/debit notification (camt.054)	72
7.8.	Statement of IP cover account (camt.053).....	74
7.9.	IP liquidity position report (camt.052)	78

The "Functional Specification of the instant payment service of the Electronic Clearing System of Latvijas Banka (EKS)" (hereinafter, the Specification) establishes the indications for generating the messages to be processed by the instant payment service of the electronic clearing system of Latvijas Banka (hereinafter, the EKS) and the structure of the messages associated with their processing as well as instructions for exchanging messages in relation to participant's TIPS DCA.

The terms used in the Specification are consistent with the terms used in Appendix 1 "System Rules for Participation in the EKS" to Latvijas Banka's Council Procedure No. 183/3 "Participation Procedure in Latvijas Banka's Electronic Clearing System" of 9 September 2010 and their explanations.

The process flows and their descriptions have been included in the present Specification for reference only.

The indicators used in message and file descriptions are as follows:

- a) field status indicators:
 - M – mandatory,
 - O – optional;
 - C – conditional;
- b) field format indicators:
 - n – numbers (from 0 to 9),
 - a – alphabetical character,;
 - c – capital letters of the Latin alphabet and numbers,
 - x – any UTF-8 character compliant with the requirements of Paragraph 2.1 herein;
- c) field length indicators:
 - nn – maximum field length (minimum is 1),
 - nn! – fixed field length, e.g. 3!;
- d) IBAN, date and time indicators:
 - IBAN - see EKS schema files for details,
 - ISODate – YYYY-MM-DD,
 - ISODateTime – see EKS schema files for details.

Important! AcptncDtTm must include miliseconds, following the principle of W3C standard, where last digit milliseconds allowed only when different from zero.

Examples:

<u>Timestamps compliant with the pattern</u>	<u>Timestamps non-compliant with the pattern</u>
<u>10:10:55.035'</u>	
<u>10:10:55.24'</u>	<u>10:10:55.240'</u>
<u>10:10:55.3'</u>	<u>10:10:55.300'</u>
<u>10:10:55'</u>	<u>10:10:55.000'</u>

1. Message and file exchange in the instant payment service

The instant payment service processes messages specified in Paragraph 2 herein. Messages shall be generated in accordance with the SEPA Instant Credit Transfer Scheme Rulebook approved by the European Payments Council, the SEPA Credit Transfer Scheme Inter-PSP Implementation Guidelines (hereinafter, SCT Inst Inter-PSP IG) approved by the European Payments Council and ISO 20022 XML messaging standards (hereinafter, ISO 20022). The instant payment service validates messages against message schema for EKS Instant Payment Service published at [Latvijas Banka's website](#).

The instant payment service sends the files specified in Paragraph 2 herein to the participants. Files shall be generated in accordance with the instructions specified in the Specification and using message schema for EKS Instant Payment Service published at [Latvijas Banka's website](#). Files are sent using File exchange service (hereinafter, the FAS) or message queues. The participant informs Latvijas Banka about the chosen option in the static data registration form.

1.1. File exchange using file exchange service

Access to the FAS takes place through the public Internet network. The FAS is provided by Bitwise WinSSHD software using Secure File Transfer Protocol (SFTP - FTP-over-SSH).

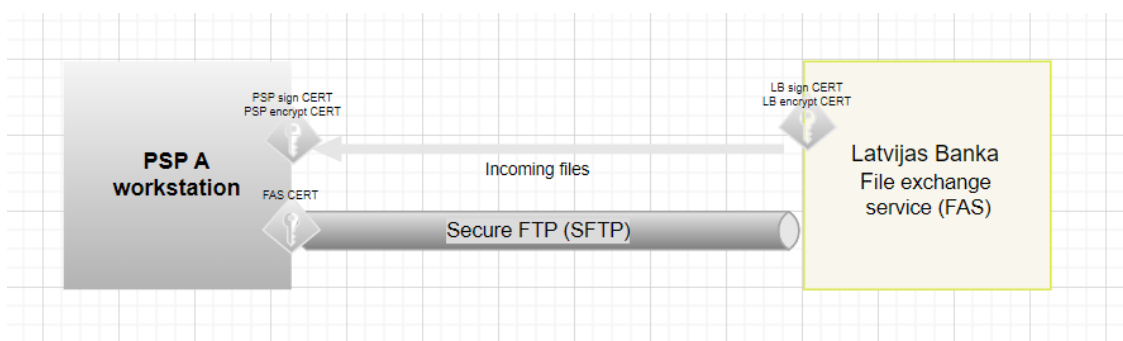

Chart 1. File exchange

If a participant uses FAS for the file exchange, participant's supervisor via ds.bank.lv creates certificates for information exchange with Latvijas Banka within the payment systems and FAS users. Separate certificates and users shall be created for test and production environment.

Instant payment service signs files sent to the participants with the keys intended for information exchange in Latvijas Banka's payment systems as well as encrypts them for the users created by the participant's supervisors for information exchange in Latvijas Banka's payment systems. Files sent by the instant payment service are available for download by the participants in the folder FEKS\In.

Participants use Latvijas Banka's tool "*SecureFileExchange*" to decrypt files sent by the instant payment service (documentation and installation of the tool is available at <https://ds.bank.lv>).

1.2. Message and file exchange using message queues

Messages between the participants and the instant payment service are exchanged using the Advanced Message Queuing Protocol (AMQP) - message exchange protocol ensuring

high-performance, safe and guaranteed delivery of messages to recipients. AMQP is an open standard protocol with publicly available specifications; therefore, it is a platform independent solution enabling messaging between client applications based on various operating systems and written in various programming languages. AMQP may be used also for receiving files from the instant payment service, if a participant chooses this option in the static data registration form.

The TLS protocol is used for secure data transmission. TLS certificate created via ds.bank.lv by the participant's supervisor are used to ensure the security of the message exchange channel.

Access to the instant payment service infrastructure is allowed only from IP addresses registered via ds.bank.lv by the participant's supervisor. In addition, Latvijas Banka provides the participant with the access rights of RabbitMQ users.

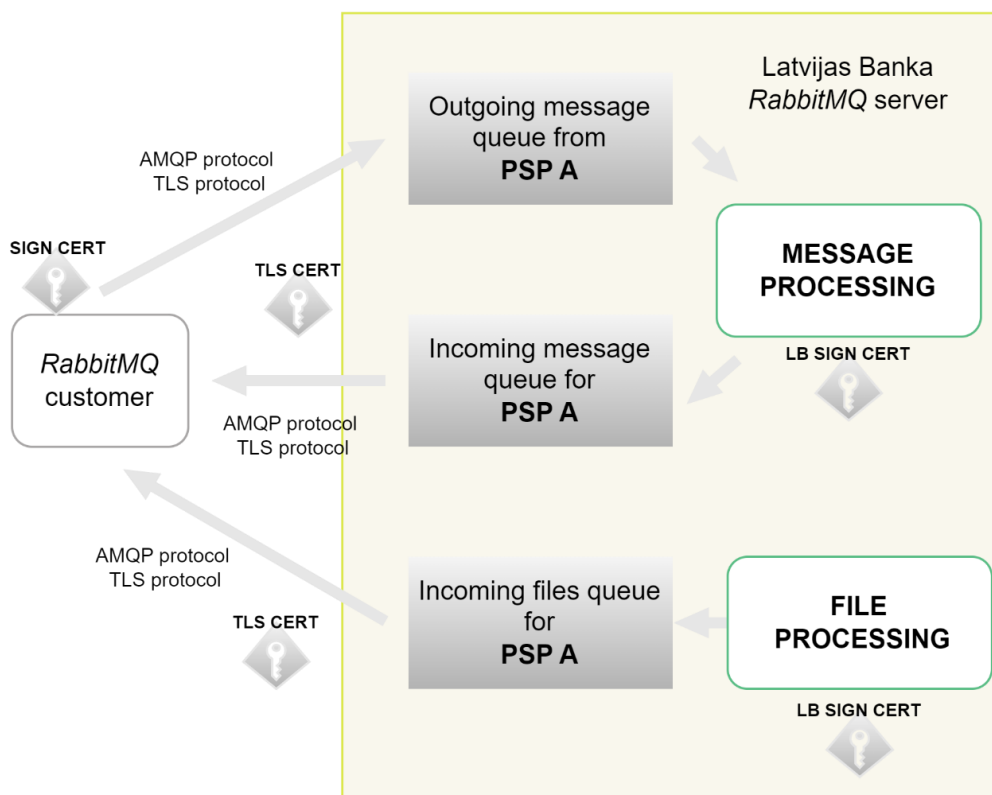

Chart 2. Message and file exchange using message queues

To ensure high system availability, the instant payment service uses a RabbitMQ server cluster consisting of 3 server instances. In case one of the instances is not available, the participant can send the message to another instance of the cluster. A participant application must be able to provide a connection with another instance of the cluster in case of unavailability.

The instant payment service infrastructure intended for testing is separated from the infrastructure of the production environment. Separate instances are created and used for testing, separate message queues are configured, and certificates for testing purposes are registered. The participant's configuration parameters for each of the environments are communicated to the participant before the start of the tests in the test environment and before the start of using the instant payment service in the production environment.

Latvijas Banka recommends choosing a higher-level client library based on the official RabbitMQ libraries, which would be able to automatically restore a terminated connection to one of several defined server cluster addresses. Information about clients is available here: <https://www.rabbitmq.com/>.

1.3. Configuration of queues

The names of queues (for receiving messages and files) and exchange (for sending messages) are created according to the following rules:

<type E or Q>.<4 symbols from participant BIC>_<participant's identifier assigned by Latvijas Banka in the system>

For example: E.BIC4_1234

Name	Value	Comment
RabbitMQ server instance	Test: at-rabbit1.bank.lv, at-rabbit2.bank.lv at-rabbit3.bank.lv Production: e-rabbit1.bank.lv, e-rabbit2.bank.lv, e-rabbit3.bank.lv	
Authentication type	EXTERNAL	The participant's authentication certificate must be provided upon connecting
VirtualHost for messages	feks	
VirtualHost for files	mqfiles	
Sending messages	Exchange: E.<participant's identifier> routingKey: payment response info	The message is sent specifying the relevant routingKey
Receiving messages	Queues: Q.<participant's identifier>.payment Q.<participant's identifier>.response Q.<participant's identifier>.info	Messages are received by reading the respective queue
Receiving files	Queues: Q.<participant's identifier>. FEKS	Files are received by reading the respective queue

1.4. Message and file signing

Participant's supervisor, using licences of the advanced security system for online message exchange issued by Latvijas Banka, creates TLS and signing certificates via ds.bank.lv. Alternatively, participant can use other means of electronic identification at his disposal for signing messages exchanged with instant payment service in accordance with Latvijas Banka's regulation stipulating the procedure for electronic exchange of information.

Where participant is using FAS for the file exchange, participant's supervisor via ds.bank.lv creates also certificates for information exchange with Latvijas Banka within the payment systems and FAS users.

1.4.1. Message signing

The following messages shall be signed electronically by the participants and the instant payment service:

- instant payment messages (pacs.008);
- instant payment cancellation request messages (camt.056);
- instant payment return messages (pacs.004);
- instant payment resolution of investigation messages (camt.029).

To allow the verification of the message signature, the public part of the certificate shall be included in the signature attributes. An XML document signing scheme, recommended by World Wide Web Consortium (W3C), shall be used for signing. The entire message shall be signed, incorporating the signature in the message content. When verifying the signature, the signature part shall not be included in the message checksum calculation.

Message signature contents:

```
<Signature xmlns="http://www.w3.org/2000/09/xmldsig#">
<SignedInfo>
  <CanonicalizationMethod
    Algorithm="http://www.w3.org/TR/2001/REC-xml-c14n-20010315"/>
  <SignatureMethod
    Algorithm=" http://www.w3.org/2001/04/xmldsig-more#ecdsa-sha256"/>
  <Reference URI="">
    <Transforms>
      <Transform
        Algorithm=" http://www.w3.org/2000/09/xmldsig#enveloped-
signature "/>
    </Transforms>
    <DigestMethod Algorithm="
http://www.w3.org/2001/04/xmlenc#sha256"/>
    <DigestValue></DigestValue>
  </Reference>
</SignedInfo>
<SignatureValue></SignatureValue>
<KeyInfo>
<X509Data>
  <X509Certificate></X509Certificate>
</X509Data>
</KeyInfo>
</Signature>
```

Description of mandatory elements of the signature

Element	Attributes	Description
CanonicalizationMethod	Algorithm="http://www.w3.org/TR/2001/REC-xml-c14n-20010315"	The following shall be indicated: <i>http://www.w3.org/TR/2001/REC-xml-c14n-20010315.</i>
SignatureMethod	Algorithm="http://www.w3.org/2001/04/xmldsig-more#ecdsa-sha256 "	Represents the signature algorithm. The following shall be indicated: <i>http://www.w3.org/2001/04/xmldsig-more#ecdsa-sha256.</i>
Reference	URI="	Define reference to the message section to be signed. As the entire message will be signed and the signature will be added after signing, URI=" shall be indicated.
Transform	Algorithm="http://www.w3.org/2000/09/xmldsig#enveloped-signature "	The method used for adding the electronic signature has to be indicated: <i>http://www.w3.org/2000/09/xmldsig#enveloped-signature.</i>
DigestMethod	Algorithm="http://www.w3.org/2001/04/xmenc#sha256"	Represents the checksum calculation algorithm. The following shall be indicated: <i>http://www.w3.org/2001/04/xmenc#sha256.</i>
DigestValue		Indicates the message checksum. The value shall be indicated in base64 encoding.
SignatureValue		Indicates the electronic signature of the message. The value shall be indicated in base64 encoding.
X509Certificate		Indicates the certificate used for signing the message. The value shall be indicated in base64 encoding.

To send a message to the instant payment service, a participant:

- 1) Prepares the message in compliance with the Specifications;
- 2) Performs XML canonicalization (REC-xml-c14n-20010315) to produce a standardized form of the XML document for signing;
- 3) Computes the checksum (hash) of the XML data using the SHA-256 algorithm;
- 4) Creates a <SignedInfo> element that includes mandatory elements of the signature as specified in the sample and table herein;
- 5) Computes the checksum (hash) (SHA-256) for the whole <SignedInfo> element and signs the message checksum using the private key of the message review certificate accepted by Latvijas Banka;
- 6) To allow the verification of the signature, the public part of the certificate shall be included in the signature attributes under <X509Data> element;
- 7) Publishes the message to the RabbitMQ server, specifying the exchange name and the routing key (RoutingKey).

The instant payment service verifies the signature of the received message and the validity of the signing certificate.

To receive a message from the instant payment service, a participant:

- 1) Reads the message from the queue;
- 2) Performs XML canonicalization (REC-xml-c14n-20010315);
- 3) Computes the checksum (hash) of the message content (without <Signature> element) using the SHA-256 algorithm;
- 4) Verifies hash of the message content and hash provided in <DigestValue> element of <SignedInfo> element;

- 5) Computes the hash of <SignedInfo> element using the SHA-256 algorithm;
- 6) Decrypts the encrypted digest (which is part of the SignatureValue element of the received message) using the public key of the certificate attached to the message attributes (ECC) and compares to hash of <SignedInfo> element ;
- 7) Verifies that the issuer of the attached certificate is Latvijas Banka and that the certificate is on the list of authorized signing certificates (the list is published at <https://ds.bank.lv/pubkeys>). The comparison is done by comparing the serial number of the certificate attached to the signature with the serial numbers of the published certificates. Note that to ensure certificate rotation, multiple certificates may be used and published simultaneously.

1.4.2. File signing, if message queues are used for file exchange

The following files shall be signed electronically by the instant payment service:

- IP liquidity position report (camt.052);
- statement of IP cover account (camt.053).

If the files are sent using message queues, instant payment service uses for signing the keys issued by Latvijas Banka (ECC).

To receive a file from Latvijas Banka's systems, using message queues, a participant:

- 1) Reads the message from the queue;
- 2) Reads attributes of the message:
 - a. FileName – the name of the file;
 - b. SegmentCount - the total number of file segments (indicate =1);
 - c. SegmentNumber - the current file segment sequence number (indicate=1);
 - d. FileHash – the file's checksum (base64 encoded);
 - e. SignatureValue - the file's signature (base64 encoded);
 - f. X509Certificate - public part of the signing certificate;
- 3) Saves the content of the report to the disk as a file with the name specified in the FileName parameter;
- 4) Calculates the checksum (hash) of the file content using the SHA-256 algorithm;
- 5) Verifies the file signature using the public key of the certificate attached to the message attributes (ECC);
- 6) Verifies that the issuer of the attached certificate is Latvijas Banka and that the certificate is on the list of authorized signing certificates (the list is published at <https://ds.bank.lv/pubkeys>). The comparison is done by comparing the serial number of the certificate attached to the signature with the serial numbers of the published certificates. Note that to ensure certificate rotation, multiple certificates may be used and published simultaneously.

2. The format of messages and files, message routing

2.1. The format to be used for generating messages

2.1.1. Common format to be used for generating messages

Participants shall maintain the following set of UTF-8 characters:

- capital letters of the Latin alphabet (from A to Z);
- small letters of the Latin alphabet (from a to z);
- digits;
- characters – '/', '-', '?', ':', '(', ')', '!', ',', '"', '+';
- space.

UTF-8 encoding is used for character encoding with a respective indication in the XML file header.

Example

```
<?xml version="1.0" encoding="UTF-8">
```

Following the SCT Inst Inter-PSP IG, the character set for references and identifiers is restricted to Latin characters. In respect to other fields the instant payment service transmits all UTF-8 characters without verifying which sets of characters are supported by each participant. A participant is allowed to reject a payment message where the characters not listed in this Paragraph have been used, if the participant has not agreed to their processing.

If the instant payment service receives an ISO-compliant message with a prefix in the XML element tag, it forwards the message unchanged. A participant is not allowed to reject messages that contain prefix only based on the usage of prefix, but has also no obligation to use the same prefix in the reply message.

An example of using the prefix "NS1" in an XML message:

```
<NS1:FIToFICstmrCdtTrf xmlns:NS1="urn:LBFastCdtTrf:xsd:$LB.FastEKS.CdtTrf">
<NS1:GrpHdr xmlns:NS1="urn:iso:std:iso:20022:tech:xsd:pacs.008.001.08">
<NS1:MsgId>MCH22082300000UD9</NS1:MsgId>
```

2.1.2. The format to be used for message identifiers

Message identifiers shall meet following condition:

- maximum length is 35 characters;
- only characters 0-9 a-z A-Z / - ? : () . , ' + and space can be used;
- leading or trailing spaces are not allowed;
- may not contain double slash "//";
- may not start or end with slash "/" .

2.2. Messages and routing

The instant payment service receives and processes the following individual messages.

Message name	Message type	Sending institution	Message queue
Payment messages			
Instant payment message	pacs.008.001.08	EKS or participant	PAYMENT
Instant payment return message	pacs.004.001.09	EKS or participant	PAYMENT
Information messages			
Instant payment cancellation request message	camt.056.001.08	EKS or participant	PAYMENT
Instant payment resolution of investigation message	camt.029.001.09	EKS or participant	PAYMENT
Instant payment status investigation request message	pacs.028.001.03	EKS or participant	RESPONSE
Instant payment status message	pacs.002.001.10	EKS or participant	RESPONSE
Reply message to an incoming erroneous message	LB.FastEKS.CrptMsg	EKS	RESPONSE
Current IP liquidity position request message	camt.060.001.05	Participant	INFO
Current IP liquidity position message	camt.052.001.08	EKS	INFO
Technical maintenance message	admi.004.001.02	EKS	INFO
IP liquidity position credit/debit notification	camt.054.001.08	EKS	INFO

The messages to be submitted by participants to the instant payment service may be addressed to those EKS participants using the instant payment service and addressable BIC holders as well as the entities reachable via the TIPS platform - only for BIC11s specified in the routing table (see Charts 3 and 4).

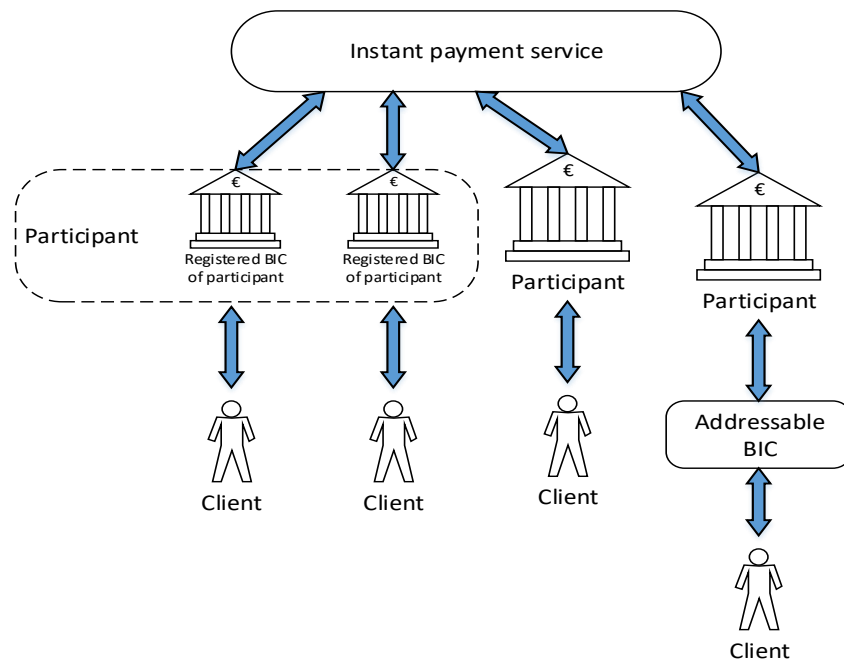

Chart 3. The operational process flow of the instant payment service for exchanging messages between the participants

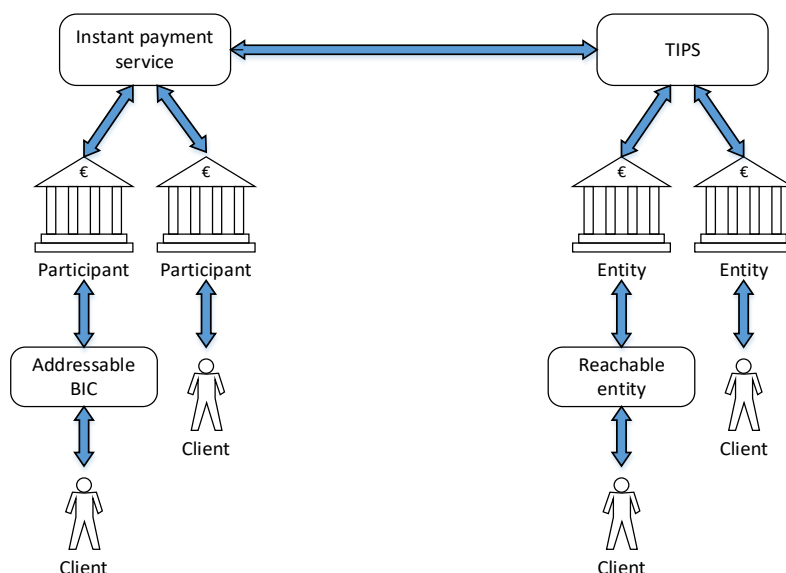

Chart 4. Operational process flow of the instant payment service for exchanging messages with entities reachable via the TIPS platform

Latvijas Banka shall establish and maintain a list containing information on entities reachable via the instant payment service (a routing table). Any changes to the routing table shall take effect on the date when a list is received or on the date specified in the table upon the valuation date change.

The routing table is a text file with the following structure:

No.	Element	Format	Description
1.	Name	105a	Name.
2.	BIC	11a	11-digit BIC or 8-digit BIC with the extension "XXX".
3.	Valid from	8n	Date when the data become valid (YYYYMMDD).
4.	Valid until	8n	Date up to which the data are valid (YYYYMMDD).
5.	Type of participation	2n	Refers to the participant's reachability: "05" – participant of the instant payment service; "06" – addressable BIC holder of the instant payment service; "20" – participant of another payment system.

The participants can receive information on entities reachable in TIPS platform by subscribing to "TIPS Directory" report in TIPS CRDM. The relevant file shall be formatted and sent to the participants in accordance with TIPS technical/functional documentation without involvement of the instant payment service.

2.3. Forwarding messages addressed to the participant's, that is a participant in TARGET, TIPS DCA account

The instant payments service in the role of instructing party, within the meaning of Latvijas Banka's rules for participation in TARGET-Latvija, ensures transmission of the following messages related to the participant's TIPS DCA:

Message name	Message type	Sending institution	Message queue
Payment messages			
Instant payment message	pac.008.001.08	TIPS	PAYMENT
Instant payment return message	pac.004.001.09	TIPS or participant	PAYMENT
Information messages			
Instant payment cancellation request message	camt.056.001.08	TIPS	PAYMENT
Instant payment resolution of investigation message	camt.029.001.09	TIPS or participant	PAYMENT
Instant payment status investigation request message	pac.028.001.03	TIPS	RESPONSE
Instant payment status message	pac.002.001.10	TIPS or participant	RESPONSE
TIPS DCA credit/debit notification	camt.054.001.06	TIPS or participant	INFO

Upon receiving the incoming instant payment message pac.008.001.08 which is addressed to the participant and in which the BIC reachable on the participant's TIPS DCA is specified in the <CdtrAgt> field, the instant payment service forwards the received message to the participant without making changes to the participant's IP cover account.

When refunding instant payment that was addressed to the BIC reachable on the participant's TIPS DCA, the participant ensures that the BIC code indicated in the pac.004.001.09 <CdtrAgt> field of the instant payment return message corresponds to the BIC reachable on the participant's TIPS DCA. Upon receipt of such pac.004.001.09, the instant payment service forwards the instant payment return message without making changes to the participant's IP cover account.

When configuring the TIPS DCA in accordance with the *Reference and Static Data Registration User Guide* and the TIPS technical/functional documentation published on the [ECB website](#), the participant specifies *o=lacblv2x,o=swift* as instructing party DN.

2.4. Files sent by the instant payment service

The instant payment service generates the following files and make them available to participants for downloading at the file exchange service folder FEKS\IN or sends them using message queues.

Name	Message type	File name and file naming principles	Preparing the file for sending	File sending frequency
IP liquidity position report	camt.052	"RPGGGGMMDDHHnn n.xml", where a variable part "GGGGMMDDHH" represents the date and time when the file is created, a variable part "nnn" represents the report page sequence number.	Each file contains one message/report page. Each report page contains max 100,000 entries. Where a report has more than 100,000 entries, it shall be divided in several messages/report pages. Each file shall be zipped (with the file extension ".zip" if sent using FAS and ".gz" if sent using MQ) and signed. If the file is sent using FAS, it shall be also encrypted (the extension of an encrypted file is ".p7m").	Every day.
Statement of IP cover account	camt.053	"AMPGGGGMMDDnnn.xml", where a variable part "GGGGMMDD" represents the date when the file is created, a variable part "nnn" represents the report page sequence number.	Each file contains one message/statement page. Each statement page contains max 100,000 entries. Where a statement has more than 100,000 entries, it shall be divided in several messages/statement pages. Each file shall be zipped (with the file extension ".zip" if sent using FAS and ".gz" if sent using MQ) and signed. If the file is sent using FAS, it shall be also encrypted (the extension of an encrypted file is ".p7m").	On TARGET business days.
Routing table	Text file.	"AMSGGGGMMDD.txt", where a variable part "GGGGMMDD" is the date when the updated table teakes effect.	The file shall be zipped (with the file extension ".zip" if sent using FAS and ".gz" if sent using MQ).	Every day.

3. Timetable¹ of the instant payment service

3.1. For the participant, that is a participant in TARGET

Instant payment service business hours	24/7/365
Generating and transmission of the IP liquidity position report of the previous calendar date	Every day at 12.05 a.m. to 12.35 a.m.
Balancing of the initial IP liquidity position	On TARGET business days at 8.30 a.m. to 9.00 a.m.
Processing of requests on changes in the instant payment liquidity positions of the participants	24/7/365
End-of-day processing	On TARGET business days at 7.05–7.10 p.m.
Generating and transmission of the statement of IP cover account of the settlement day	On TARGET business days at 7.05–7.35 p.m.

Latvijas Banka may change the timetable of the instant payment service in contingency situations.

3.2. For the participant, that is not a participant in TARGET

Instant payment service business hours	24/7/365
Generating and transmission of the IP liquidity position report of the previous calendar date	Every day at 12.05 a.m. to 12.35 a.m.
Processing of requests on decrease in the instant payment liquidity position	On TARGET business days at 8.00 a.m. to 4.00 p.m.
Automatic decrease in the instant payment liquidity position	On TARGET business days at 4.00 p.m.
Processing of requests on increase in the instant payment liquidity position	On TARGET business days at 8.00 a.m. to 6.00 p.m.
End-of-day processing	On TARGET business days at 7.05–7.10 p.m.
Generating and transmission of the statement of IP cover account of the settlement day	On TARGET business days at 7.05–7.35 p.m.

Latvijas Banka may change the timetable of the instant payment service in contingency situations.

¹ The timetable represents activities scheduled in Latvian time

4. Process flow of instant payment order processing

According to the SEPA Instant Credit Transfer Scheme Rulebook approved by the European Payments Council, the following timeline shall apply to the execution of an instant payment.

Timestamp indicated in the <AcceptncDtTm> field of pacs.008.

5 seconds – target maximum execution time.

7 seconds - hard-time deadline. The CSM of the creditor agent must have received an instant payment status message from the creditor agent.

9th second - instant payment status message must reach the debtor agent. If not, investigation procedure may start.

10 seconds - if the debtor agent has not received an instant payment status message within 10 seconds, it immediately restores the debtor's payment account to the state in which it would have been had the instant payment has not taken place, by lifting the reservation of the amount made on the debtor's payment account.

Process flows of the instant payment order processing (see Charts 5-12) depict the sequence of the instant payment service procedures.

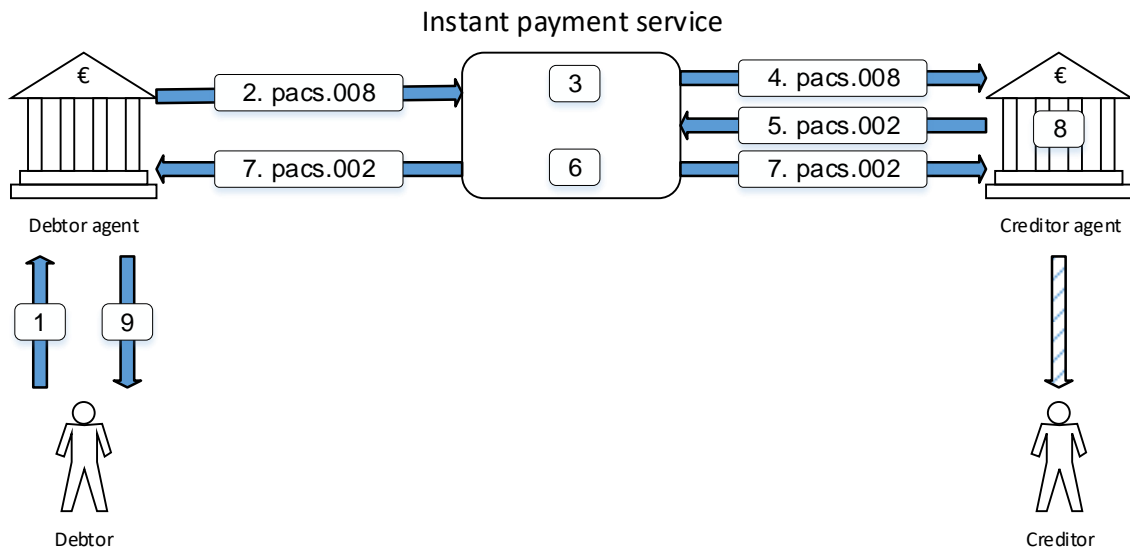

Chart 5. Successful execution of the instant payment order when the debtor agent and the creditor agent both are the EKS participants using the instant payment service.

1. The debtor initiates an instant payment (the EKS does not set any format requirements).
2. The debtor agent sends an instant payment message (pacs.008) to the instant payment service.
3. The instant payment service validates the instant payment message and reserves the respective amount of the debtor agent's instant payment liquidity position.

4. The instant payment service sends the instant payment message (pacs.008) to the creditor agent.
5. The creditor agent confirms (pacs.002) that the instant payment can be credited to the creditor's account.
6. The instant payment service uses the funds reserved on the debtor agent's instant payment liquidity position to increase the creditor agent's instant payment liquidity position.
7. The instant payment service sends the debtor agent and the creditor agent a confirmation (pacs.002) of the instant payment execution.
8. The creditor agent credits the creditor's account.
9. The debtor agent sends its customer a confirmation that funds have been credited to the creditor's account.

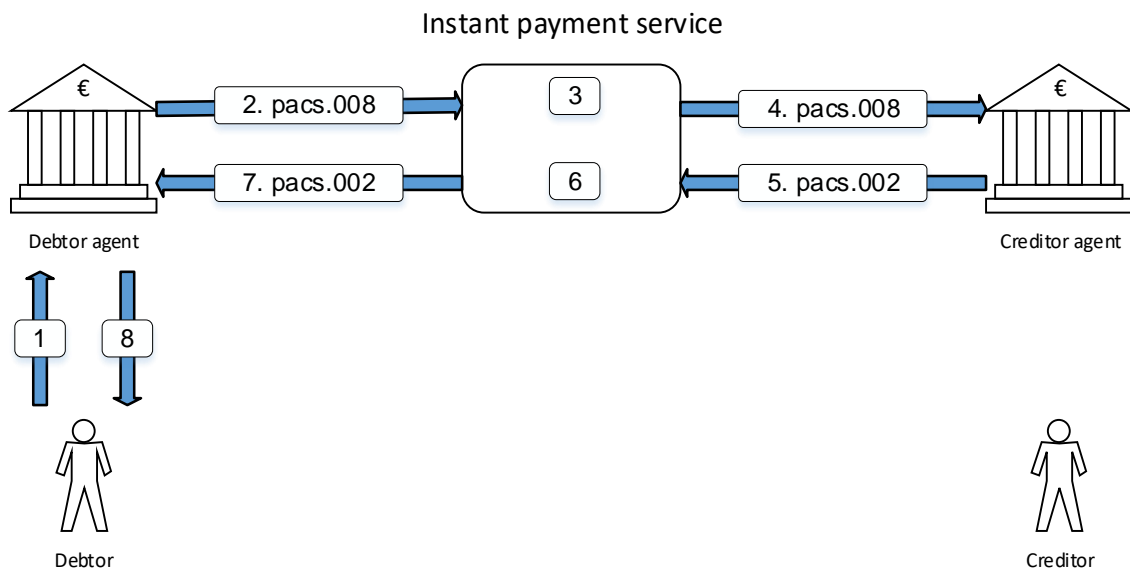

Chart 6. Rejection of the instant payment order when the debtor agent and the creditor agent both are the EKS participants using the the instant payment service

1. The debtor initiates an instant payment.
2. The debtor agent sends an instant payment message (pacs.008) to the instant payment service.
3. The instant payment service validates the instant payment message and reserves the respective amount of the debtor agent's instant payment liquidity position.
4. The instant payment service sends the instant payment message (pacs.008) to the creditor agent.
5. The creditor agent sends a notification (pacs.002) that the payment cannot be credited to the creditor's account.
6. The instant payment service cancels the reservation on debtor agent's instant payment liquidity position.
7. The instant payment service sends a rejection (pacs.002) to the debtor agent.
8. The debtor agent sends its customer information on the payment rejection.

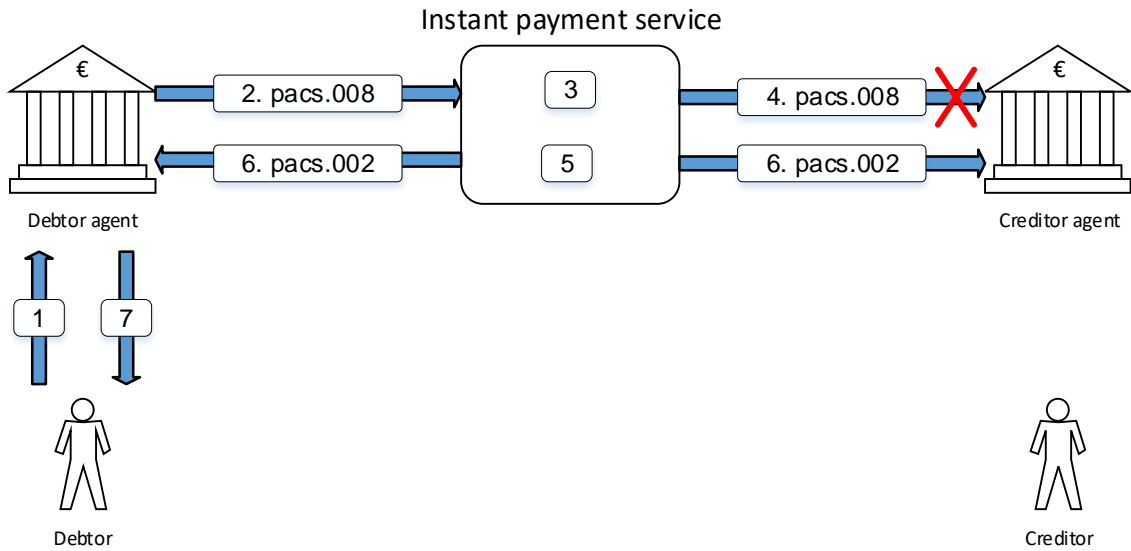

Chart 7. Rejection of the instant payment order because of a time-out when the debtor agent and the creditor agent both are the EKS participants using the instant payment service

1. The debtor initiates an instant payment.
2. The debtor agent sends an instant payment message (pacs.008) to the instant payment service.
3. The instant payment service validates the instant payment message and reserves the respective amount of the debtor agent's instant payment liquidity position.
4. The instant payment service sends the instant payment message (pacs.008) to the creditor agent, but due to technical reasons the creditor agent fails to receive the message.
5. Within the pre-defined period of time (~~20~~7 seconds), the instant payment service has not received a reply, it rejects the instant payment and cancels the reservation of the instant payment liquidity position.
6. The instant payment service sends the debtor agent and the creditor agent a notification (pacs.002) of the instant payment rejection.
7. The debtor agent sends its customer information on the instant payment rejection.

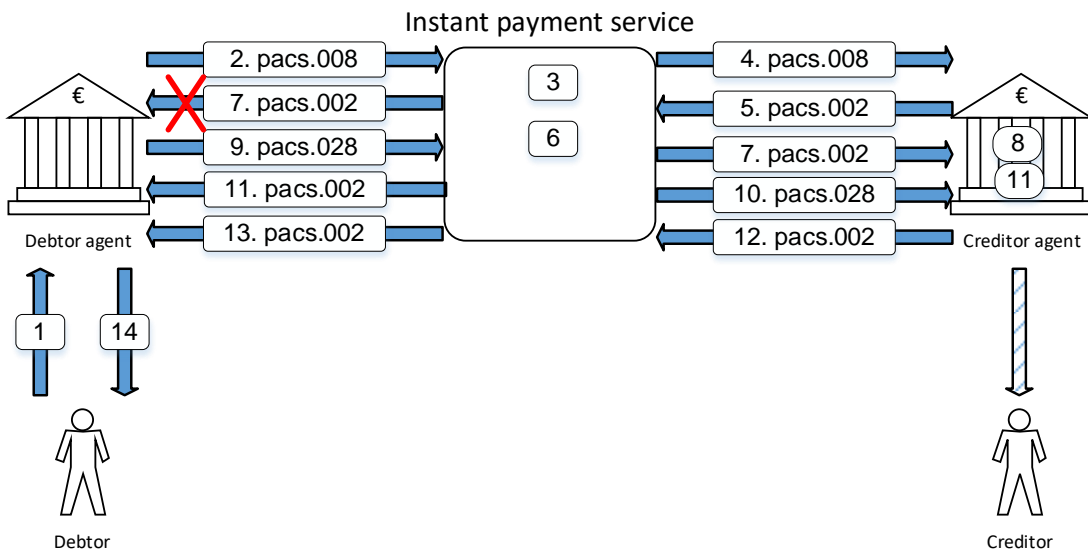

Chart 8. Instant payment status investigation (instant payment order has been executed) when the debtor agent and the creditor agent both are the EKS participants using the instant payment service

1. The debtor initiates an instant payment.
2. The debtor agent sends an instant payment message (pacs.008) to the instant payment service.
3. The instant payment service validates the instant payment message and reserves the respective amount of the debtor agent's instant payment liquidity position.
4. The instant payment service sends the instant payment message (pacs.008) to the creditor agent.
5. The creditor agent confirms (pacs.002) that the instant payment can be credited to the creditor's account.
6. The instant payment service uses the funds reserved on the debtor agent's instant payment liquidity position to increase the creditor agent's instant payment liquidity position.
7. The instant payment service sends the debtor agent and the creditor agent a confirmation (pacs.002) of the instant payment execution.
8. The creditor agent credits the creditor's account.
9. The debtor agent has not received a reply within the pre-defined time period (~~25~~9 seconds) and sends a payment status investigation message (pacs.028) to the instant payment service.
10. The instant payment service forwards payment status investigation message (pacs.028) to the creditor agent..
11. The creditor agent checks whether the instant payment has been executed.
12. The creditor agent sends a message (pacs.002) confirming that the instant payment has been executed.
13. The instant payment service forwards to the debtor agent information (pacs.002) that the instant payment has been executed.
14. The debtor agent sends its customer information that the instant payment has been executed.

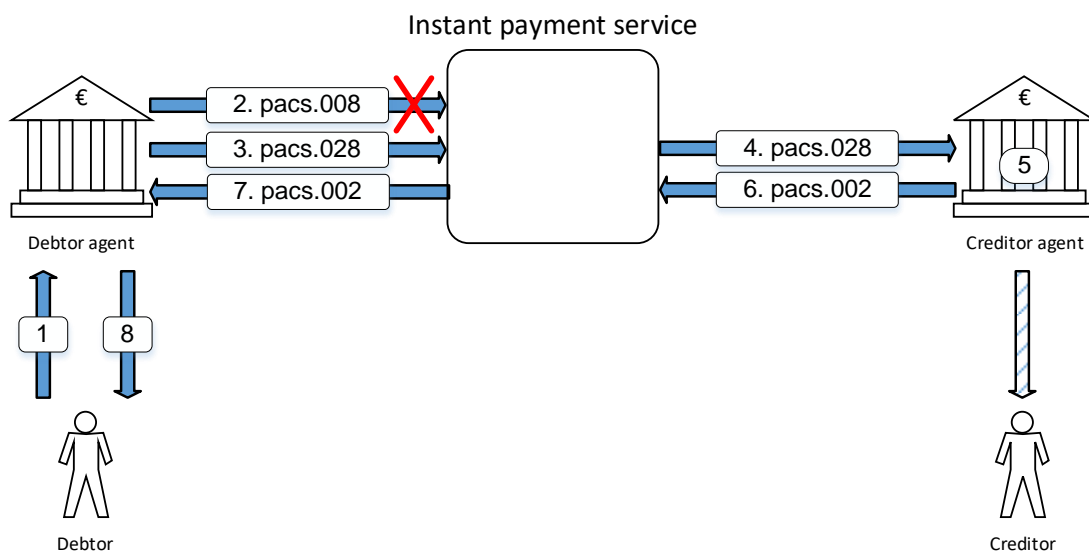

Chart 9. Instant payment status investigation (instant payment order has not been executed) when the debtor agent and the creditor agent both are the EKS participants using the instant payment service

1. The debtor initiates an instant payment.
2. The debtor agent sends an instant payment message (pacs.008) to the instant payment service, but it does not reach it.
3. The debtor agent has not received a reply within the pre-defined time period (25-9 seconds) and sends a payment status investigation message (pacs.028) to the instant payment service.
4. The instant payment service forwards payment status investigation message (pacs.028) to the creditor agent.
5. The creditor agent checks whether the instant payment has been executed.
6. The creditor agent sends a message (pacs.002) confirming that the instant payment has not been received.
7. The instant payment service forwards to the debtor agent information (pacs.002) that the instant payment has not been received.
8. The debtor agent sends its customer information that the instant payment has not been executed.

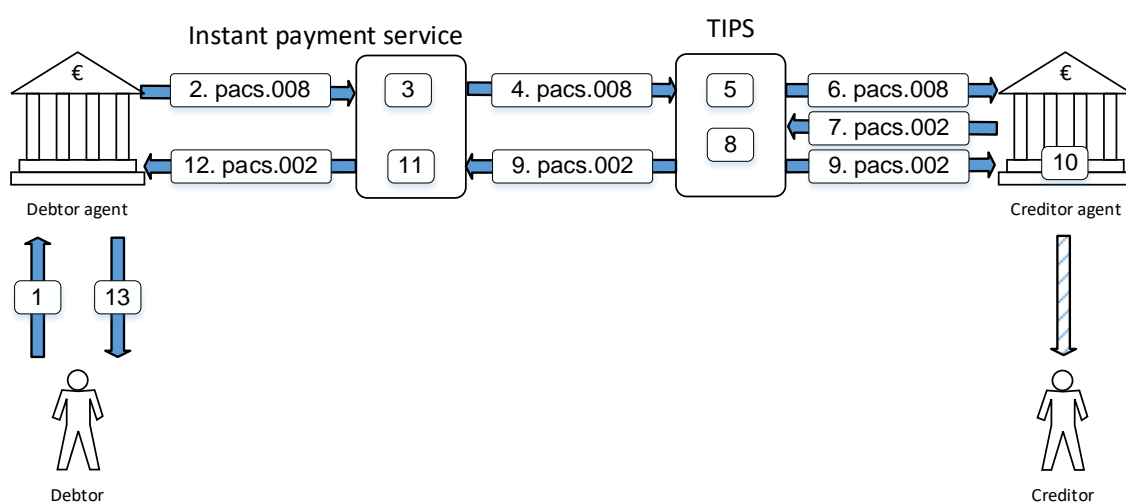

Chart 10. Execution of an instant payment order addressed to a TIPS participant with the settlement on IP cover account.

1. The debtor initiates an instant payment.
2. The debtor agent sends an instant payment message (pacs.008) to the instant payment service.
3. The instant payment service validates the instant payment message and reserves the respective amount of the debtor agent's instant payment liquidity position.
4. The instant payment service sends the instant payment message (pacs.008) to TIPS.
5. TIPS verifies the instant payment and reserves the respective amount of the liquidity.
6. TIPS sends the instant payment message (pacs.008) to the creditor agent.
7. The creditor agent confirms (pacs.002) that the instant payment can be credited to the creditor's account.
8. TIPS uses the reserved liquidity to increase the creditor agent's TIPS DCA balance.
9. TIPS sends the debtor agent and the creditor agent a confirmation (pacs.002) of the instant payment execution.
10. The creditor agent credits the creditor's account.
11. The instant payment service uses the funds reserved on the instant payment liquidity position to increase TIPS liquidity position.
12. The instant payment service sends the debtor agent information (pacs.002) that the instant payment has been executed.

13. The debtor agent sends its customer information that the instant payment has been executed.

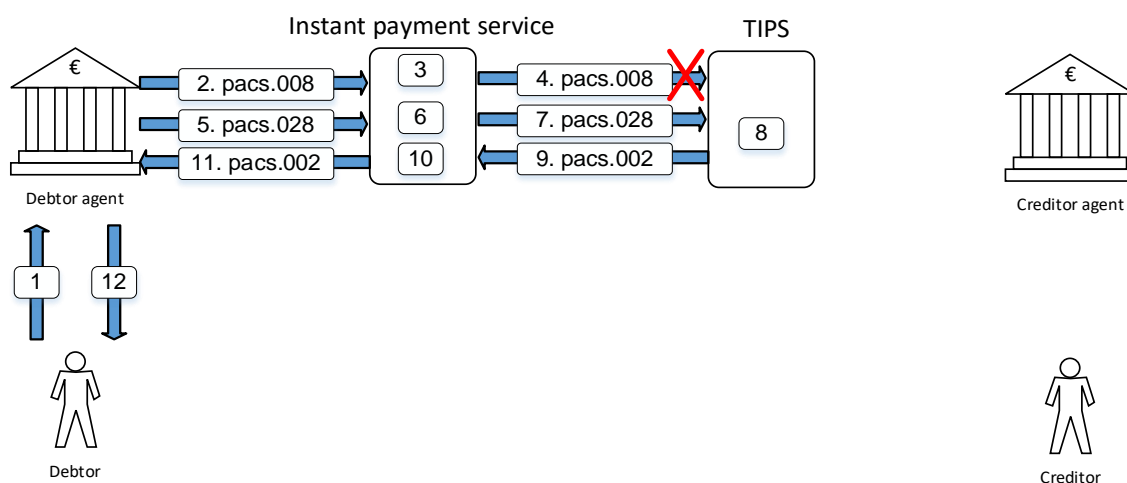

Chart 11. Processing of an instant payment order addressed to a TIPS participant involving the sending of an instant payment status investigation message (the instant payment order has not been executed).

1. The debtor initiates an instant payment.
2. The debtor agent sends an instant payment message (pacs.008) to the instant payment service.
3. The instant payment service validates the instant payment message and reserves the respective amount of the debtor agent's instant payment liquidity position.
4. The instant payment service sends the instant payment message (pacs.008) to TIPS which does not receive it (in this case, the instant payment service does not reject the instant payment within 20-7 seconds).
5. The debtor agent has not received a reply within the pre-defined time period (25-9 seconds) and sends an instant payment status investigation message (pacs.028) to the instant payment service.
6. The instant payment service checks whether a reply regarding the respective instant payment message has been received from TIPS.
7. The instant payment service sends the instant payment status investigation message (pacs.028) to TIPS.
8. TIPS conducts an instant payment search.
9. TIPS sends a message (pacs.002) informing that the instant payment has not been received.
10. The instant payment service cancels the reservation of funds on the debtor agent's instant payment liquidity position.
11. The instant payment service sends the debtor agent a message (pacs.002) informing that the instant payment has not been executed.
12. The debtor agent and the creditor agent send their customers information that the instant payment has not been executed.

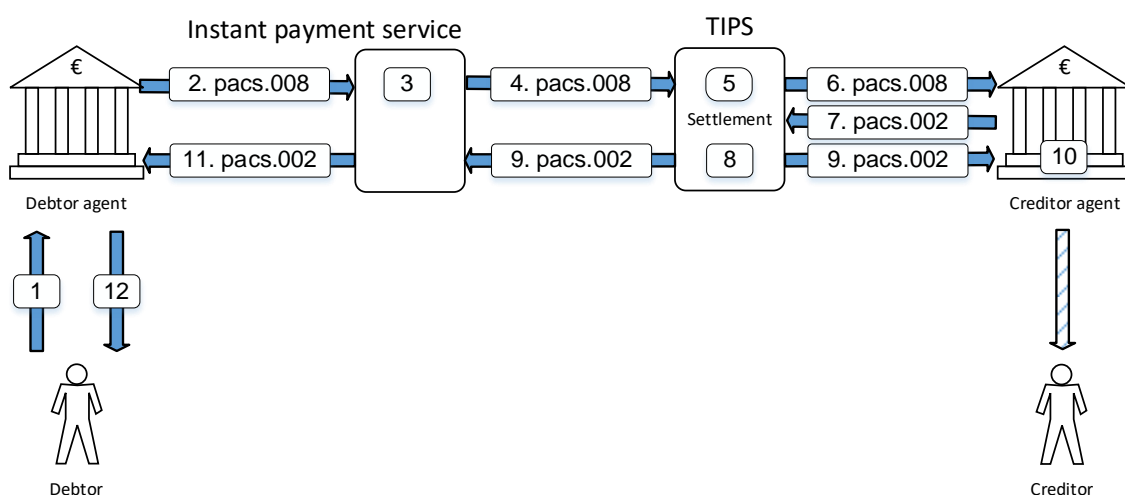

Chart 12. Processing of an instant payment order addressed to a TIPS participant with the settlement on participant's TIPS DCA.

1. The debtor initiates an instant payment.
2. The debtor agent sends an instant payment message (pacs.008) to the instant payment service.
3. The instant payment service validates the instant payment message.
4. The instant payment service sends the instant payment message (pacs.008) to TIPS.
5. TIPS verifies the instant payment and reserves the respective amount of the liquidity on participant's TIPS DCA.
6. TIPS sends the instant payment message (pacs.008) to the creditor agent.
7. The creditor agent confirms (pacs.002) that the instant payment can be credited to the creditor's account.
8. TIPS uses the reserved liquidity to increase the creditor agent's TIPS DCA balance.
9. TIPS sends the instant payment service and the creditor agent a confirmation (pacs.002) of the instant payment execution.
10. The creditor agent credits the creditor's account.
11. The instant payment service sends the debtor agent information (pacs.002) that the instant payment has been executed.
12. The debtor agent sends its customer information that the instant payment has been executed.

4.5. Process flow of instant payment cancellation request, instant payment return order and instant payment resolution of investigation processing

Process flow of instant payment cancellation request, instant payment return order and instant payment resolution of investigation processing (see Charts 13–16) depict the sequence of the instant payment service procedures.

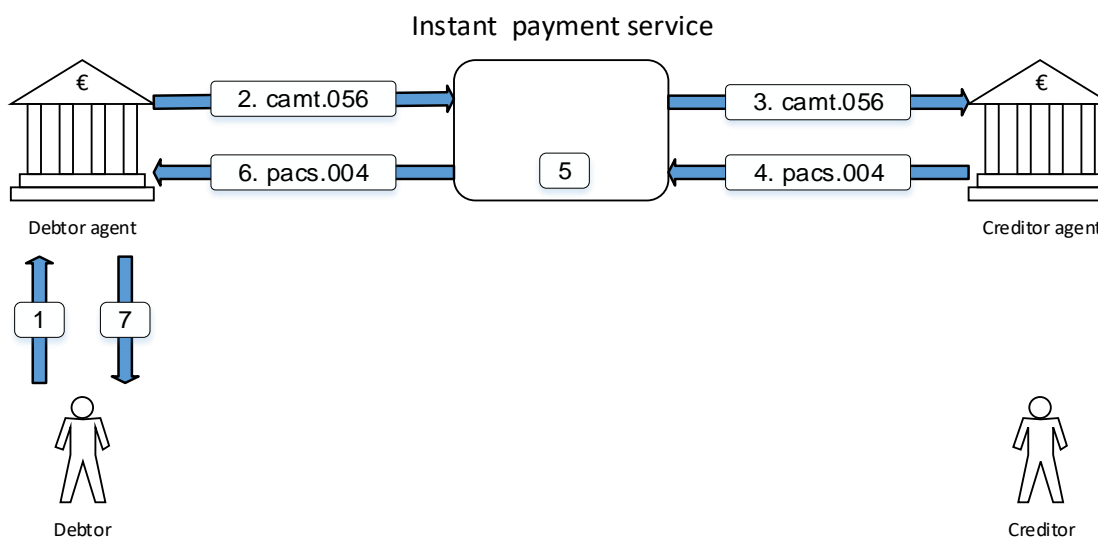

Chart 13. Successful execution of the instant payment cancellation request resulting in receiving of the refund when the debtor agent and the creditor agent both are the EKS participants using the instant payment service

1. The debtor or the debtor agent initiates an instant payment order cancellation.
2. The debtor agent sends an instant payment cancellation request message (camt.056) to the instant payment service.
3. The instant payment service sends the instant payment cancellation request message (camt.056) to the creditor agent.
4. The creditor agent sends an instant payment return message (pacs.004).
5. The instant payment service processes the instant payment return message (pacs.004), decreases the creditor agent's instant payment liquidity position and increases the debtor agent's instant payment liquidity position.
6. The instant payment service sends the instant payment return message (pacs.004) to the debtor agent.
7. The debtor agent credits its customer's account and informs the customer that the refund of instant payment has been credited to its account.

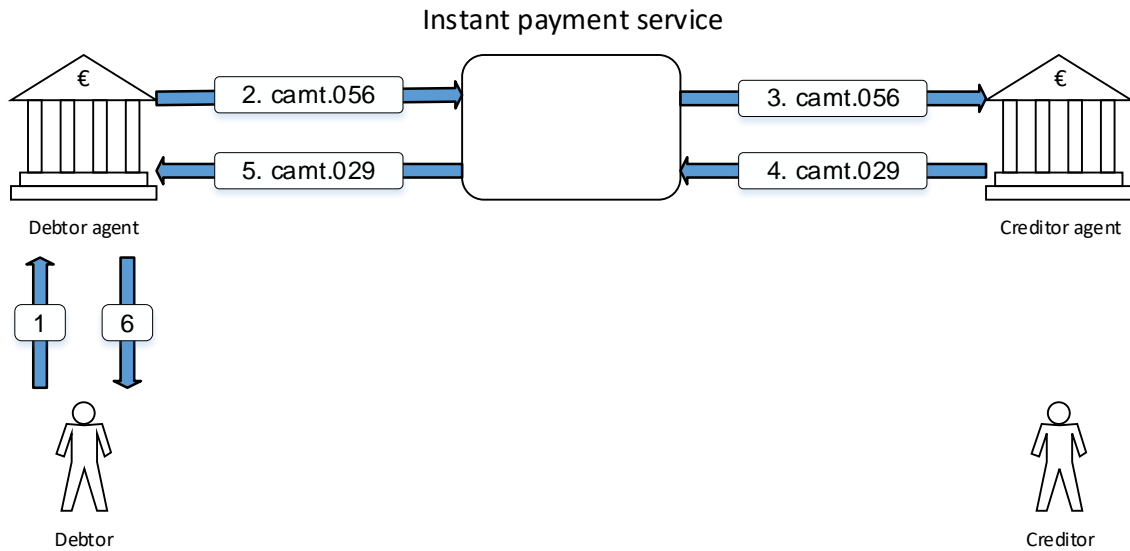

Chart 14. Successful execution of the instant payment cancellation request resulting in receiving of instant payment resolution of investigation message when the debtor agent and the creditor agent both are the EKS participants using the instant payment service

1. The debtor or the debtor agent initiates an instant payment order cancellation.
2. The debtor agent sends an instant payment cancellation request message (camt.056) to the instant payment service.
3. The instant payment service sends the instant payment cancellation request message (camt.056) to the creditor agent.
4. The creditor agent sends an instant payment resolution of investigation message (camt.029).
5. The instant payment service sends the instant payment resolution of investigation message (camt.029) to the debtor agent.
6. The debtor agent sends its customer the information on the negative response to the cancellation request.

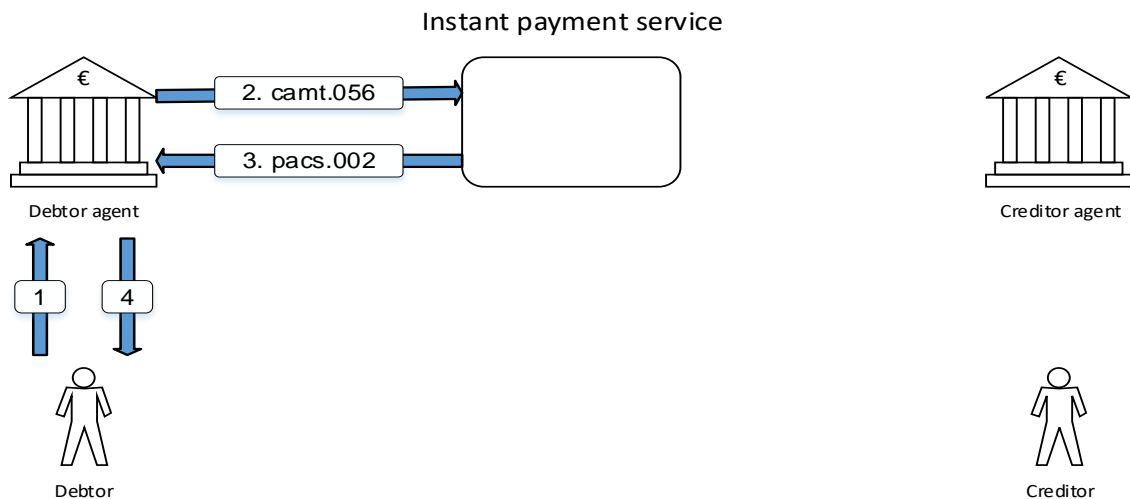

Chart 15. Unsuccessful submission of an instant payment cancellation request

1. The debtor or the debtor agent initiates an instant payment order cancellation.
2. The debtor agent sends an instant payment cancellation request message (camt.056) to the instant payment service.
3. The instant payment service detects an error and sends an error message (pacs.002) to the debtor agent.

4. The sending of the error message to the customer is not mandatory. The agents may inform their customer in line with their internal procedures.

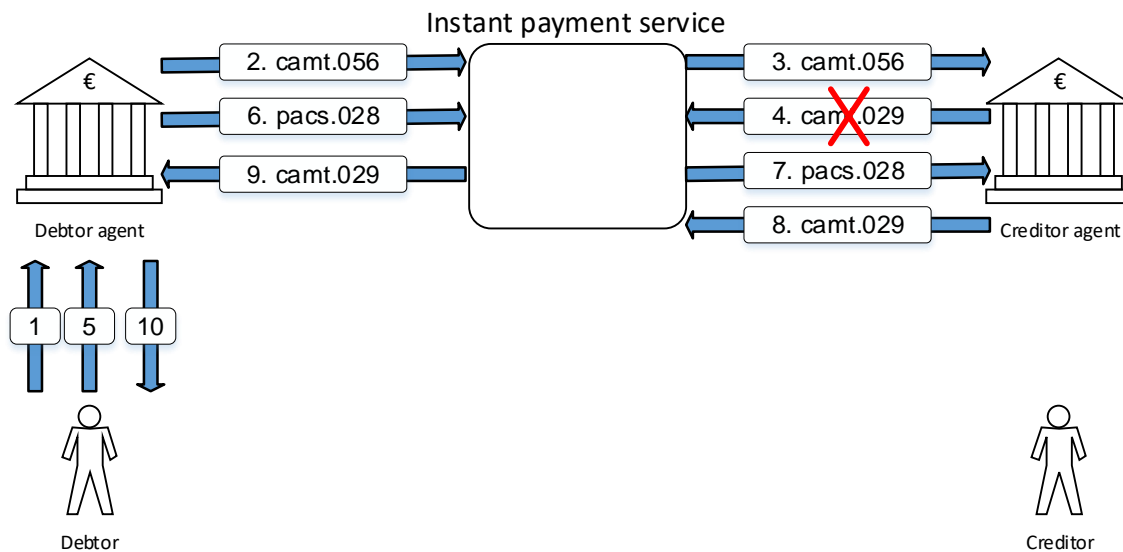

Chart 16. Sending an instant payment cancellation request and an instant payment status investigation request

1. The debtor initiates an instant payment order cancellation.
2. The debtor agent sends an instant payment cancellation request message (camt.056) to the instant payment service.
3. The instant payment service sends the instant payment cancellation request message (camt.056) to the creditor agent.
4. The creditor agent sends an instant payment resolution of investigation message (camt.029), but the instant payment service does not receive it.
5. In the absence of a reply, the debtor agent initiates sending of an instant payment status investigation request.
6. The debtor agent sends an instant payment status investigation request message (pacs.028) to the instant payment service.
7. The instant payment service sends the instant payment status investigation message to the creditor agent.
8. The creditor agent sends an instant payment resolution of investigation message (camt.029).
9. The instant payment service sends the instant payment resolution of investigation message (camt.029) to the debtor agent.
10. The debtor agent sends its customer the information on the negative response to the cancellation request..

5.6. Generating messages

5.4.6.1. Instant payment message (pacs.008.001.08)

An instant payment message shall be generated in accordance with ISO 20022 pacs.008.001.08 message.

Structure of the message

Element	Format or data type	Status	Description	Notes
<LBFastCdtTrf>	Set of elements			
<FIToFICstmrCdtTrf>	Set of elements	M		
<GrpHdr>	Set of elements	M	Credit transfer message bulk information	One occurrence of the element is allowed.
<CdtTrfTxInf>	Set of elements	M	Credit transfer message information	One occurrence of the element is allowed.
<Signature>	Set of elements	M	Signature	One occurrence of the element is allowed.

Bulk header

Element	Format or data type	Status	Description	Notes
<GrpHdr>	Set of elements	M	Instant payment message bulk information	One occurrence of the element is allowed.
<MsgId>	35x	M	Bulk identifier	Must be used as specified in Paragraph 2.1.2 herein.
<CreDtTm>	ISODatetime	M	Date and time of bulk creation	
<NbOfTxS>	15n	M	Number of instant payment messages in the bulk	Number of instant payment messages in the bulk. Only value "1" is allowed.
<TtlIntrBkSttlmAmt>	18d EUR	M	Amount of instant payment messages in the bulk	Must be equal to the total amount of all instant payment messages in the bulk.
<IntrBkSttlmDt>	ISODate	M	Value date	
<SttlmInf>	Set of elements	M		

	<Prtry>	35x	Or}		Cannot be used at the same time as <Cd>.
	<InstgAgt>	Set of elements	M	Instructing agent	The participant BIC shall be indicated in the messages to be sent to the instant payment service. The agent who submitted the message to the instant payment service is indicated in the messages received from the instant payment service.
	<FinInstnId>	Set of elements	M		
	<BICFI>	4! c2!a2!c	M	BIC of the Instructing Agent	
	<InstdAgt>	Set of elements	M	Instructed Agent	The BIC of Latvijas Banka shall be indicated in the messages to be sent to the instant payment service. The participant BIC is indicated in the messages received from the instant payment service.
	<FinInstnId>	Set of elements	M		
	<BICFI>	4! c2!a2!c	M	BIC of the Instructed Agent	

Instant payment message structure

Element	Format or data type	Status	Description	Notes
<CdtTrfTxInf>	Set of elements	M	Instant payment message information	One occurrence of the element is allowed.
<PmtId>	Set of elements	M	Payment identification	
<InstrId>	35x	O	Instruction identification	Assigned by the instructing agent of the instant payment. Must be used as specified in Paragraph 2.1.2 herein.
<EndToEndId>	35x	M	Identification assigned by the debtor	Where it is not available, only value "NOTPROVIDED" is allowed. Must be used as specified in Paragraph 2.1.2 herein.
<TxId>	35x	M	Message identification	Assigned by the debtor agent. Must be used as specified in Paragraph 2.1.2 herein.
<IntrBkSttlmAmt>	18d EUR	M	Interbank settlement amount	<u>According to SCT Inst Inter-PSP IG, amount must be 0.01 or more and 999999999.99 or less.</u>
<AcptncDtTm>	ISODatetime	M	Time stamp of instant payment message acceptance	<u>Timestamps must be unambiguous and include milliseconds. The representation of milliseconds must follow the W3C recommendation, where last digit milliseconds allowed only when different from zero.</u>
<ChrgBr>	Code	M	Charge bearer	Only code "SLEV" is allowed.
<UltmtDbtr>	Set of elements	O	Ultimate debtor	
<Nm>	70x	O	Name	
<Id>	Set of elements	M	Ultimate debtor identification	

	<OrgId>	Set of elements	{Or}	Organisation identification	Cannot be used at the same time as <PrvtId>. <u>According to SCT Inst Inter-PSP IG, either <AnyBIC>, <LEI> and/or one occurrence of <Othr> is allowed.</u>
	<AnyBIC>	4!c2!a2!c[3!c]	+ Or O	BIC	According to SCT Inst Inter-PSP IG, cannot be used at the same time as <LEI> or <Othr>.
	<LEI>	18!c2!n	O Or F	LEI code	Cannot be used at the same time as <AnyBIC> or <Othr>.
	<Othr>	Set of elements	O Or +	Other type of identification	According to SCT Inst Inter-PSP IG, cannot be used at the same time as <AnyBIC> or <LEI>.
	<Id>	35x	M	Identifier	
	<SchmeNm>	Set of elements	O	Scheme name	
	<Cd>	Code	{Or}	Scheme name code	Only ISO 20022 <i>ExternalOrganisationIdentification1Code</i> codes are allowed. Cannot be used at the same time as <Prtry>.
	<Prtry>	35x	Or}	Scheme name	Cannot be used at the same time as <Cd>.
	<Issr>	35x	O	Issuer of identifier	
	<PrvtId>	Set of elements	Or}	Natural person identification	Cannot be used at the same time as <OrgId>.
	<DtAndPlcOfBirth>	Set of elements	O	Date and place of birth	According to SCT Inst Inter-PSP IG, cannot be used at the same time as <Othr>.
	<BirthDt>	ISODate	M	Date of birth	
	<PrvcOfBirth>	35x	O	Province of birth	
	<CityOfBirth>	35x	M	City of birth	
	<CtryOfBirth>	2!a	M	Country of Birth	Only ISO 3166 Alpha-2 codes are allowed.
	<Othr>	Set of elements	O	Other type of identification	Cannot be used at the same time as <DtAndPlcOfBirth>.
	<Id>	35x	M	Identifier	
	<SchmeNm>	Set of elements	O	Scheme name	
	<Cd>	Code	{Or}	Scheme name code	Only ISO 20022 <i>ExternalPersonIdentification1Code</i> codes are allowed. Cannot be used at the same time as <Prtry>.
	<Prtry>	35x	Or}	Scheme name	Cannot be used at the same time as <Cd>.
	<Issr>	35x	O	Issuer of identifier	
	<Dbtr>	Set of elements	M	Debtor	
	<Nm>	70x	M	Debtor name	
	<PstlAdr>	Set of elements	E C	Address	According to SCT Inst Inter-PSP IG:

	<Id>	Set of elements	O	Debtor identification	
	<OrgId>	Set of elements	{Or	Organisation identification	Cannot be used at the same time as <PrvtId>. <u>According to SCT Inst Inter-PSP IG, either <AnyBIC>, <LEI> and/or one occurrence of <Othr> is allowed.</u>
	<AnyBIC>	4!c2!a2!c[3!c]	O f	BIC	Cannot be used at the same time as <LEI> un <Othr>.
	<LEI>	18!c2!n	O f	LEI code	Cannot be used at the same time as <AnyBIC> or <Othr>.
	<Othr>	Set of elements	O f	Other type of identification	Cannot be used at the same time as <AnyBIC> or <LEI>.
	<Id>	35x	M	Identifier	
	<SchmeNm>	Set of elements	O	Scheme name	
	<Cd>	Code	{Or	Scheme name code	Only ISO 20022 ExternalOrganisationIdentificationCode codes are allowed. Cannot be used at the same time as <Prtry>.
	<Prtry>	35x	Or}	Scheme name	Cannot be used at the same time as <Cd>.
	<Issr>	35x	O	Issuer of identifier	
	<PrvtId>	Set of elements	Or}	Natural person identification	Cannot be used at the same time as <OrgId>.
	<DtAndPlcOfBirth>	Set of elements	O	Date and place of birth	Cannot be used at the same time as <Othr>.
	<BirthDt>	ISODate	M	Date of birth	
	<PrvcOfBirth>	35x	O	Province of birth	
	<CityOfBirth>	35x	M	City of birth	
	<CtryOfBirth>	2!a	M	Country of birth	Only ISO 3166 Alpha-2 codes are allowed.
	<Othr>	Set of elements	O	Other type of identification	Cannot be used at the same time as <DtAndPlcOfBirth>.
	<Id>	35x	M	Identifier	
	<SchmeNm>	Set of elements	O	Scheme name	
	<Cd>	Code	{Or	Scheme name code	Only ISO 20022 ExternalPersonIdentificationCode codes are allowed. Cannot be used at the same time as <Prtry>.
	<Prtry>	35x	Or}	Scheme name	Cannot be used at the same time as <Cd>.
	<Issr>	35x	O	Issuer of identifier	
	<DbtrAcct>	Set of elements	M	Debtor account	

	<Id>	Set of elements	M	Debtor account identification	
	<IBAN>	IBAN	M	IBAN	
	<Prxy>	Set of elements	O	Proxy	According to SCT Inst Inter-PSP IG, can only be provided here under the condition that the Originator is given the possibility to validate the IBAN linked to that Proxy, prior to the authentication of the instruction unless the Originator and the Originator PSP agreed upfront on another arrangement. Furthermore, the Originator PSP must have an agreement with the Originator and the Beneficiary PSP with the Beneficiary in relation to the treatment and the use of the data provided under such Alias/Proxy i.e. whether it is to be used for the purpose to initiate the transaction and/or to forward it to the Beneficiary PSP and/or the Beneficiary concerned.
	<Tp>	Set of elements	O	Proxy type	
	<Cd>	4x	{Or	Proxy type code	Only ISO 20022 <i>ExternalProxyAccountType1Code</i> are allowed. Cannot be used at the same time as <Prtry>.
	<Prtry>	35x	Or}	Proxy type	
	<Id>	320x	M	Proxy ID	
	<DbtrAgt>	Set of elements	M	Debtor agent	
	<FinInstnId>	Set of elements	M	Financial institution identification	
	<BICFI>	4!c2!a2!c[3!c]	M	BIC	The specified BIC shall be available in the routing table.
	<CdtrAgt>	Set of elements	M	Creditor agent	
	<FinInstnId>	Set of elements	M	Financial institution identification	
	<BICFI>	4!c2!a2!c[3!c]	M	BIC	The specified BIC shall be available in the routing table.
	<Cdtr>	Set of elements	M	Creditor	
	<Nm>	70x	M	Creditor name	
	<PstlAdr>	Set of elements	O	Address	According to SCT Inst Inter-PSP IG: STRUCTURED: Usage is recommended. <TwnNm Town Name > and <CountryCtry> are mandatory. <AdrLine Address Line > is not allowed. It is recommended to provide as many structured elements as possible.

					<p><u>HYBRID: <TwnNm> and <Ctry> are mandatory. At least one occurrence of <AdrLine> is mandatory.</u></p> <p><u>UNSTRUCTURED: (As of 22 November 2026 at 03:30 CET only the use of structured and hybrid addresses will be allowed): At least one occurrence of <AdrLine> is mandatory. <PstlAdr> sub-elements other than <AdrLine> and <Ctry> are forbidden. The use of <Ctry> is mandatory when either the Debtor Agent or Creditor Agent is located in a non-EEA SEPA country or territory.</u></p> <p><u>1) If <AdrLine> is not used then at least <TwnNm> and <Ctry> must be used;</u></p> <p><u>2) Not allowed to use <AdrLine> then <PstlAdr> sub-elements other than <Ctry> are not allowed.</u></p>	
	—	<Dept>	70x	O	Department	
	—	<SubDept>	70x	O	Sub Department	
	—	<StrtNm>	70x	O	Street Name	
	—	<BldgNb>	16x	O	Building Number	
	—	<BldgNm>	35x	O	Building Name	
	—	<Flr>	70x	O	Floor	
	—	<PstBx>	16x	O	Post Box	
	—	<Room>	70x	O	Room	
	—	<PstCd>	16x	O	Post Code	
	—	<TwnNm>	35x	O	Town Name	
	—	<TwnLctnNm>	35x	O	Town Location Name	
	—	<DstrctNm>	35x	O	District Name	
	—	<CtrySubDvsn>	35x	O	Country Sub Division	
	—	<Ctry>	2!a	O	Country	Only ISO 3166 Alpha-2 codes are allowed.
	—	<AdrLine>	70x	O	Address line	No more than two occurrences of the element are allowed.
	└	<Id>	Set of elements	O	Creditor identification	
	└	<OrgId>	Set of elements	{Or	Organisation identification	Cannot be used at the same time as <PrvtId>.
	└	<AnyBIC>	4!c2!a2!c[3!c]	O	BIC	Cannot be used at the same time as <LEI> or <Othr>.
	└	<LEI>	18!c2!n	Or	LEI code	
	└	<Othr>	Set of elements	O	Other type of identification	Cannot be used at the same time as <AnyBIC> vai <LEI>.
	└	<Id>	35x	M	Identifier	

		<SchmeNm>	Set of elements	O	Scheme name	
		└─ <Cd>	Code	{Or	Scheme name code	Only ISO 20022 ExternalOrganisationIdentification1Code codes are allowed. Cannot be used at the same time as <Prtry>.
		└─ <Prtry>	35x	Or}	Scheme name	Cannot be used at the same time as <Cd>.
		└─ <Issr>	35x	O	Issuer of identifier	
		└─ <PrvtId>	Set of elements	Or}	Natural person identification	Cannot be used at the same time as <OrgId>.
		└─ <DtAndPlcOfBirth>	Set of elements	O	Date and place of birth	Cannot be used at the same time as <Othr>.
		└─ <BirthDt>	ISODate	M	Date of birth	
		└─ <PrvcOfBirth>	35x	O	Province of birth	
		└─ <CityOfBirth>	35x	M	City of birth	
		└─ <CtryOfBirth>	2!a	M	Country of birth	Only ISO 3166 Alpha-2 codes are allowed.
		└─ <Othr>	Set of elements	O	Other type of identification	Cannot be used at the same time as <DtAndPlcOfBirth>.
		└─ <Id>	35x	M	Identifier	
		└─ <SchmeNm>	Set of elements	O	Scheme name	
		└─ <Cd>	Code	{Or	Scheme name code	Only ISO 20022 ExternalPersonIdentification1Code codes are allowed. Cannot be used at the same time as <Prtry>.
		└─ <Prtry>	35x	Or}	Scheme name	Cannot be used at the same time as <Cd>.
		└─ <Issr>	35x	O	Issuer of identifier	
		└─ <CdtrAcct>	Set of elements	M	Creditor account	
		└─ <Id>	Set of elements	M	Creditor account identification	
		└─ <IBAN>	IBAN	M	IBAN	
		└─ <Prxy>	Set of elements	O	Proxy	According to SCT Inst Inter-PSP IG, can only be provided here under the condition that the Originator is given the possibility to validate the IBAN linked to that Proxy, prior to the authentication of the instruction unless the Originator and the Originator PSP agreed upfront on another arrangement. Furthermore, the Originator PSP must have an agreement with the Originator and the Beneficiary PSP with the Beneficiary in relation to the treatment and the use of the data provided under such Alias/Proxy i.e. whether it is to be used for the purpose to initiate the transaction and/or to forward it to the Beneficiary PSP and/

					or the Beneficiary concerned.
	<Tp>	Set of elements	O	Proxy type	
	<Cd>	4x	{Or	Proxy type code	Cannot be used at the same time as <Prtry>.
	<Prtry>	35x	Or}	Proxy type	Cannot be used at the same time as <Cd>.
	<Id>	320x	M	Proxy ID	
	<UltmtCdtr>	Set of elements	O	Ultimate creditor	
	<Nm>	70x	O	Name	
	<Id>	Set of elements	M	Ultimate creditor identification	
	<OrgId>	Set of elements	{Or	Organisation identification	Cannot be used at the same time as <PrvtId>.
	<AnyBIC>	Identifier	{Or	BIC	Cannot be used at the same time as <LEI> or <Othr>.
	<LEI>	18!c2!n	Or	LEI code	Cannot be used at the same time as <AnyBIC> or <Othr>.
	<Othr>	Set of elements	Or}	Other type of identification	Cannot be used at the same time as <AnyBIC> or <LEI>.
	<Id>	35x	M	Identifier	
	<SchmeNm>	Set of elements	O	Scheme name	
	<Cd>	Code	{Or	Scheme name code	Only ISO 20022 ExternalOrganisationIdentification1 Code codes are allowed. Cannot be used at the same time as <Prtry>.
	<Prtry>	35x	Or}	Scheme name	Cannot be used at the same time as <Cd>.
	<Issr>	35x	O	Issuer of identifier	
	<PrvtId>	Set of elements	Or}	Natural person identification	Cannot be used at the same time as <OrgId>.
	<DtAndPlcOfBirth>	Set of elements	O	Date and place of birth	According to SCT Inst Inter-PSP IG, cannot be used at the same time as <Othr>.
	<BirthDt>	ISODate	M	Date of birth	
	<PrvcOfBirth>	35x	O	Province of birth	
	<CityOfBirth>	35x	M	City of birth	
	<CtryOfBirth>	2!a	M	Country of birth	Only ISO 3166 Alpha-2 codes are allowed.
	<Othr>	Set of elements	O	Other type of identification	According to SCT Inst Inter-PSP IG, cannot be used at the same time as <DtAndPlcOfBirth>.
	<Id>	35x	M	Identifier	
	<SchmeNm>	Set of elements	O	Scheme name	
	<Cd>	Code	{Or	Scheme name code	Only ISO 20022 ExternalPersonIdentification1 Code codes are allowed. Cannot be used at the same time as <Prtry>.
	<Prtry>	35x	Or}	Scheme name	Cannot be used at the same time as <Cd>.
	<Issr>	35x	O	Issuer of identifier	

<Purp>	Set of elements	O	Payment purpose	
└─ <Cd>	Code	M	Payment purpose ISO code	Only ISO 20022 ExternalPurpose1Code codes are allowed.
<RmtInf>	Set of elements	O	Remittance information	
└─ <Ustrd>	140x	{Or	Unstructured	Cannot be used at the same time as <Strd>.
└─ <Strd>	Set of elements	Or}	Structured	Cannot be used at the same time as <Ustrd>. Only one occurrence of element is allowed with a maximum of 140 characters.
<CdtrRefInf>	Set of elements	O	Creditor reference information	
└─ <Tp>	Set of elements	O	Creditor reference information type	
└─ <CdOrPrtry>	Set of elements	M		
└─└─ <Cd>	Code	M	Creditor reference information type code	Only code "SCOR" is allowed. Allowed to use only with <Ref> .
└─ <Issr>	35x	O	Issuer of creditor reference information type.	
<Ref>	35x	O	Saņēmēja piešķirta maksājuma reference	Atļauts lietot tikai kopā ar <Cd>.

5.2.6.2 Instant payment return message (pacs.004.001.09)

An instant payment return message shall be generated in accordance with ISO 20022 pacs.004.001.09 message.

Structure of the message

Element	Format or data type	Status	Description	Notes
<LBFastPmtRtr>	Set of elements			
└─ <PmtRtr>	Set of elements	M		
└─┬─ <GrpHdr>	Set of elements	M	Instant payment return message bulk information	One occurrence of the element is allowed.
└─┬─┬─				
└─┬─ <OrgnlGrpInf>	Set of elements	C	Information on the original bulk	One occurrence of the element is allowed.
└─┬─┬─				
└─┬─ <TxInf>	Set of elements	M	Message information	One occurrence of the element is allowed.
└─┬─┬─				
└─ <Signature>	Set of elements	M	Signature	One occurrence of the element is allowed.
└─┬─				

Bulk header

Element	Format or data type	Status	Description	Notes
└─ <GrpHdr>	Set of elements	M	Instant payment return message bulk information	One occurrence of the element is allowed.
└─┬─ <MsgId>	35x	M	Bulk identifier	Must be used as specified in Paragraph 2.1.2 herein.
└─┬─ <CreDtTm>	ISODateTime	M	Date and time of bulk creation	
└─┬─ <NbOfTxS>	15n	M	Number of instant payment return messages in the bulk	Must be equal to the actual number of instant payment return messages in the bulk. Only value "1" is allowed.
└─┬─ <TtlRtrdIntrBk SttlmAmt>	18d EUR	M	Amount of instant payment return messages in the bulk	Must be equal to the total amount of all instant payment return messages in the bulk.
└─┬─ <IntrBkSttlmDt>	ISODate	M	Value date	
└─┬─ <SttlmInf>	Set of elements	M		

	<SttlmMtd>	Code	M	Settlement method	Only following codes are allowed: <table border="1"> <tr> <td>CLRG</td> <td>Settlement is done through a payments clearing system.</td> </tr> <tr> <td>INGA</td> <td>Settlement is done by the agent instructing and forwarding the payment to the next party in the payments chain.</td> </tr> <tr> <td>INDA</td> <td>Settlement is done by the agent instructed to execute a payment instruction.</td> </tr> <tr> <td>COVE</td> <td>Cover payment.</td> </tr> </table>	CLRG	Settlement is done through a payments clearing system.	INGA	Settlement is done by the agent instructing and forwarding the payment to the next party in the payments chain.	INDA	Settlement is done by the agent instructed to execute a payment instruction.	COVE	Cover payment.
	CLRG	Settlement is done through a payments clearing system.											
	INGA	Settlement is done by the agent instructing and forwarding the payment to the next party in the payments chain.											
	INDA	Settlement is done by the agent instructed to execute a payment instruction.											
COVE	Cover payment.												
<SttlmAcct>	Set of elements	O	Settlement account										
	<Id>	Set of elements	M	Settlement Account									
	<IBAN>	IBAN	{Or	Identifier	According to SCT Inst Inter-PSP IG, cannot be used at the same time as <Othr> .								
	<Othr>	Set of elements	Or}	IBAN	According to SCT Inst Inter-PSP IG, cannot be used at the same time as <IBAN> .								
	<Id>	34x	M	Other identifier of the settlement account									
	<SchmeNm>	Set of elements	O	Identifier									
	<Cd>	Code	{Or	Scheme name	Only ISO 20022 <i>ExternalAccountIdentification1Code</i> codes are allowed. Cannot be used at the same time as <Prtry> .								
	<Prtry>	35x	Or}	Scheme name code	Cannot be used at the same time as <Cd> .								
	<Issr>	35x	O	Scheme name									
	<ClrSys>	Set of elements	O	Issuer of identifier									
	<Cd>	Code	{Or	Clearing system ISO code	Only ISO 20022 <i>ExternalCashClearingSystem1Code</i> codes are allowed. Cannot be used at the same time as <Prtry> .								
	<Prtry>	Code	Or}	Clearing system proprietary code	Cannot be used at the same time as <Cd> .								
	<InstgAgt>	Set of elements	M	Instructing agent	The participant BIC shall be indicated in the messages to be sent to the instant payment service. The agent who submitted the message to the instant payment service is indicated in the messages received from the instant payment service.								

	<FinInstnId>	Set of elements	M		
	<BICFI>	4!c2!a2!c	M	BIC of the instructing agent	
	<InstdAgt>	Set of elements	M	Instructed agent	The BIC of Latvijas Banka shall be indicated in the messages to be sent to the instant payment service. The participant BIC is indicated in the messages received from the instant payment service.
	<FinInstnId>	Set of elements	M		
	<BICFI>	4!c2!a2!c	M	BIC of the instructed agent	

Bulk header of the original message structure

	<OrgnlGrpInf>	Set of elements	C	Information on the original bulk	According to SCT Inst Inter-PSP IG, "Original Group Information" elements shall be present in either "Bulk header of the original message" section or in "Instant payment return message".
	<OrgnlMsgId>	35x	M	Message identifier of the original bulk	Must be used as specified in Paragraph 2.1.2 herein.
	<OrgnlMsgNmId>	35x	M	Type of messages in the original bulk	Must begin with Code "pacs.008.001.08" - shall be used in messages to be sent to the instant payment service. If original pacs.008 was sent before migration to ISO 20022-2019 version, code "pacs.008.001.02" can be used. The addition of a variant number and version number is optional. EKS IP service does not check the correspondence of this value with respect to the version of the original message.

Instant payment return message structure

	<TxInf>	Set of elements	M	Message information	One occurrence of the element is allowed.
	<RtrId>	35x	M	Instant payment return message identifier	Must be used as specified in Paragraph 2.1.2 herein.
	<OrgnlGrpInf>	Set of elements	C	Information on the original bulk	According to SCT Inst Inter-PSP IG, "Original Group Information" elements shall be present in either "Bulk header of the original message" section or in "Instant payment return message".
	<OrgnlMsgId>	35x	M	Message identifier of the original bulk	Must be used as specified in Paragraph 2.1.2 herein.

<OrgnlMsgNmId>	Code	M	Type of messages in the original bulk	<u>Must begin with Code "pacs.008.001.08" shall be used in messages to be sent to the instant payment service. The addition of a variant number and version number is optional. If original pacs.008 was sent before migration to ISO 20022 2019 version, code "pacs.008.001.02" can be used.</u> EKS IP service does not check the correspondence of this value with respect to the version of the original message.
<OrgnlInstrId>	35x	O	Original instruction identification	Mandatory if included in the original message. Must be used as specified in Paragraph 2.1.2 herein.
<OrgnlEndToEndId>	35x	M	Original identification assigned by the debtor	Must be used as specified in Paragraph 2.1.2 herein.
<OrgnlTxId>	35x	M	Original message identification	Must be used as specified in Paragraph 2.1.2 herein.
<OrgnlIntrBkSttlmAmt>	18d EUR	M	Original interbank settlement amount	<u>According to SCT Inst Inter-PSP IG, amount must be 0.01 or more and 999999999.99 or less.</u>
<RtrdIntrBkSttlmAmt>	18d EUR	M	Returned interbank settlement amount	<u>According to SCT Inst Inter-PSP IG, amount must be 0.01 or more and 999999999.99 or less.</u>
<RtrdInstdAmt>	18d EUR	O	Returned instructed amount before deduction of charges	
<ChrgBr>	Code	O	Charge bearer	Only code "SLEV" is allowed.
<ChrgsInf>	Set of elements	O	Charges information	Only allowed in messages responding to an instant payment cancellation request.
<Amt>	18d EUR	M	Charged amount	<u>According to SCT Inst Inter-PSP IG, amount must be 0.01 or more and 999999999.99 or less.</u>
<Agt>	Set of elements	M	Party deducting charges	
<FinInstnId>	Set of elements	M		
<BICFI>	4!c2!a2!c[3!c]	M	BIC	
<InstgAgt>	Set of elements	O	Agent sending the payment cancellation request message	
<FinInstnId>	Set of elements	M		
<BICFI>	4!c2!a2!c[3!c]	M	BIC	
<InstdAgt>	Set of elements	O	Agent receiving the payment cancellation request message	
<FinInstnId>	Set of elements	M		
<BICFI>	4!c2!a2!c[3!c]	M	BIC	
<RtrRsnInf>	Set of elements	M	Return reason information	
<Orgtr>	Set of elements	M	Party originating the return	
<Nm>	70x	O	Name of the party originating the return where it is a customer	

	<Id>	Set of elements	O	Party originating the return where it is an agent	
	<OrgId>	Set of elements	M		
	<AnyBIC>	4!c2!a2!c[3!c]	M	The BIC of the party originating the return	
	<Rsn>	Set of elements	M	Return reason	
	<Cd>	Code	M	Return reason code	Only code "FOCR" is allowed.
	<AddtlInf>	105x	M	Additional information	According to SCT Inst Inter-PSP IG: 1) in case of answer to recall initiated by the Originator PSP, element shall be filled-in with the code "ATR053/" followed by the instant payment cancellation request message identification indicated in camt.056 (field <CxId>); 2) in case of answer to a recall initiated by the Originator a Recall code "ATR072/" shall be used , followed by the instant payment cancellation request message identification indicated in camt.056 (element <CxId>).
	<OrgnlTxRef>	Set of elements	M	Information on the original message	According to SCT Inst Inter-PSP IG, sub-elements should contain an exact copy of elements of the received pacs.008. Sub-elements are validated only against xml schema.
	<IntrBkSttlmDt>	ISODate	O	Value date	
	<SttlmInf>	Set of elements	O		
	<SttlmMtd>	Code	O	Settlement method	
	<SttlmAcct>	Set of elements	O	Settlement account	Sub-element structure must be aligned with pacs.008.001.08.
	<ClrSys>	Set of elements	O	Identification of the clearing system	Sub-element structure must be aligned with pacs.008.001.08.
	<PmtTpInf>	Set of elements	O		
	<SvcLvl>	Set of elements	O	Service Level	Sub-element structure must be aligned with pacs.008.001.08.
	<LclInstrm>	Set of elements	O	User community specific instrument information	Sub-element structure must be aligned with pacs.008.001.08.
	<CtgyPurp>	Code	O	Category purpose	Sub-element structure must be aligned with pacs.008.001.08.
	<RmtInf>	Set of elements	O	Remittance Information	
	<Ustrd>	140x	O	Unstructured	
	<Strd>	Set of elements	O	Structured	Sub-element structure must be aligned with pacs.008.001.08.

	<UltmtDbtr>	Set of elements	O	Ultimate debtor	
	└─ <Pty>	Set of elements	M	Party	
	└─ <Nm>	70x	O	Name	
	└─ <Id>	Set of elements	M	Ultimate debtor identification	
	└─┬─ <OrgId>	Set of elements	{Or	Organisation identification	Sub-element structure must be aligned with pacs.008.001.08.
	└─┬─				
	└─┬─ <PrvtId>	Set of elements	Or}	Natural person identification	Sub-element structure must be aligned with pacs.008.001.08.
	└─┬─				
	└─ <Dbtr>	Set of elements	O	Debtor	
	└─┬─ <Pty>	Set of elements	M	Party	
	└─┬─ <Nm>	70x	M	Debtor name	
	└─┬─ <PstlAdr>	Set of elements	O	Address	Sub-element structure must be aligned with pacs.008.001.08.
	└─┬─				
	└─┬─ <Id>	Set of elements	O	Debtor identification	
	└─┬─┬─ <OrgId>	Set of elements	{Or	Organisation identification	Sub-element structure must be aligned with pacs.008.001.08.
	└─┬─┬─				
	└─┬─┬─ <PrvtId>	Set of elements	Or}	Natural person identification	Sub-element structure must be aligned with pacs.008.001.08.
	└─┬─┬─				
	└─ <DbtrAcct>	Set of elements	M	Debtor account	
	└─┬─ <Id>	Set of elements	M	Debtor account identification	
	└─┬─┬─ <IBAN>	IBAN	M	IBAN	
	└─┬─┬─ <Prxy>	Set of elements	O	Proxy	Sub-element structure must be aligned with pacs.008.001.08.
	└─┬─┬─				
	└─ <DbtrAgt>	Set of elements	M	Debtor agent	
	└─┬─ <FinInstnId>	Set of elements	M	Financial institution identification	
	└─┬─┬─ <BICFI>	4!c2!a2!c[3!c]	M	BIC	
	└─┬─┬─				
	└─ <CdtrAgt>	Set of elements	M	Creditor agent	
	└─┬─ <FinInstnId>	Set of elements	M	Financial institution identification	
	└─┬─┬─ <BICFI>	4!c2!a2!c[3!c]	M	BIC	
	└─┬─┬─				
	└─ <Cdtr>	Set of elements	O	Creditor	
	└─┬─ <Pty>	Set of elements	M	Party	
	└─┬─ <Nm>	70x	M	Creditor name	
	└─┬─ <PstlAdr>	Set of elements	O	Address	Sub-element structure must be aligned with pacs.008.001.08.
	└─┬─				
	└─┬─ <Id>	Set of elements	O	Creditor identification	
	└─┬─┬─ <OrgId>	Set of elements	{Or	Organisation identification	
	└─┬─┬─				
	└─┬─┬─ <PrvtId>	Set of elements	Or}	Natural person identification	Sub-element structure must be aligned with pacs.008.001.08.
	└─┬─┬─				

	<CdtrAcct>	Set of elements	M	Creditor Account	Sub-element structure must be aligned with pacs.008.001.08.
	├─ <Id>	Set of elements	M	Creditor account identification	
	├─ <IBAN>	IBAN	M	IBAN	
	└─ <Prxy>	Set of elements	O	Proxy	Sub-element structure must be aligned with pacs.008.001.08.
	└─ <UltmtCdtr>	Set of elements	O	Ultimate creditor	
	└─ <Pty>	Set of elements	M	Party	
	├─ <Nm>	70x	O	Name	
	└─ <Id>	Set of elements	O	Ultimate creditor identification	
	└─┬─ <OrgId>	Set of elements	{Or	Organisation identification	Sub-element structure must be aligned with pacs.008.001.08.
	└─┬─ <PrvtId>	Set of elements	Or}	Natural person identification	Sub-element structure must be aligned with pacs.008.001.08.
	└─ <Purp>	Set of elements	O	Payment purpose	
	└─ <Cd>	Code	M	Payment purpose ISO code	

5.3-6.3 Instant payment status message (pacs.002.001.10)

The instant payment status message is used to inform the Participant about the message status.

The table below provides a compilation of the use of major instant payment status message elements in various situations.

No.	Description	Instructing agent GrpHdr/ InstgAgt/ FinInstn Id/BIC	Bulk status OrgnlGrp InfAndSts /GrpSts	Bulk status reason code OrgnlGrpInfA ndSts/StsRsnI nf/Rsn/Cd	Bulk status originator OrgnlGrpInfA ndSts/StsRsnI nf/Orgtr/Nm	Message status TxInfAndSts/ TxSts	Message status reason TxInfAndSts/ StsRsnInf/ Rsn/Cd	Message status reason originator TxInfAndSts/Sts RsnInf/Orgtr/Id/ OrgIdBICorBEI	Original message type OrgnlGrpInf AndSts/Org nlMsgNmId	Instructed agent
1.	Confirmation by the participant that the incoming instant payment can be credited	Participant BIC	ACCP	–	–	–	–	–	pacs.008	The BIC of Latvijas Banka
2.	Rejection by the participant; instant payment cannot be credited	Participant BIC	–	–	–	RJCT	Message status reason code of the creditor agent	Creditor agent BIC	pacs.008	The BIC of Latvijas Banka
3.	Confirmation to the participant on outgoing instant payment execution	The BIC of Latvijas Banka	ACCP	–	–	–	–	–	pacs.008	Participant BIC
4.	Information to the participant that the instant payment has not been executed	The BIC of Latvijas Banka	–	–	–	RJCT	Message status reason of the creditor agent	BIC of the message status originator	pacs.008	Participant BIC
5.	Information to the participant on incoming instant payment rejection due to time-out	The BIC of Latvijas Banka	–	–	–	RJCT	TM01	The BIC of Latvijas Banka or TIPS	pacs.008	Participant BIC
6.	Information to the participant on outgoing instant payment rejection due to time-out	The BIC of Latvijas Banka	–	–	–	RJCT	AB06	The BIC of Latvijas Banka or TIPS	pacs.008	Debtor agent BIC
7.	Information to the participant on	The BIC of Latvijas Banka	RJCT	FF01	NOTAVAIL ABLE	Not used	Not used	Not used	pacs.008 camt.056	Debtor agent BIC

	message rejection due to inappropriate formats									pac.028	
8.	Information to the participant on message rejection due to inappropriate formats	The BIC of Latvijas Banka	RJCT	FF01	NOTAVAILABLE	Not used	Not used	Not used		pac.002 pac.004 cam.029	Creditor agent BIC
9.	Information to the participant on message rejection during validation	The BIC of Latvijas Banka	–	–	–	RJCT	Instant payment service error code	The BIC of Latvijas Banka		pac.008 cam.056 pac.028	Debtor agent BIC
10.	Message on message rejection during validation	The BIC of Latvijas Banka	–	–	–	RJCT	Instant payment service's error code	The BIC of Latvijas Banka		pac.002 pac.004 cam.029	Creditor agent BIC
11.	Information to the participant that the pac.008 message cannot be found	The BIC of Latvijas Banka	–	–	–	RJCT	AG09	BIC of the message status originator		pac.028	Debtor agent BIC

An instant payment status message has the following root elements.

Element	Format or data type	Status	Description	Notes
<Document>	Set of elements			
<FIToFIPmtStsRpt>	Set of elements	M		
<GrpHdr>	Set of elements	M	Instant payment status message bulk information	One occurrence of the element is allowed.
<OrgnlGrpInfAndSts>	Set of elements	M	Bulk information of the original instant payment	One occurrence of the element is allowed.
<TxInfAndSts>	Set of elements	O	Status message information	One occurrence of the element is allowed.

An instant payment status message shall be generated in accordance with ISO 20022 pac.002.001.10 message.

Element	Format or data type	Status	Description	Notes
<GrpHdr>	Set of elements	M	Instant payment status message bulk information	One occurrence of the element is allowed.
<MsgId>	35x	M	Instant payment status message bulk identifier	Must be used as specified in Paragraph 2.1.2 herein.
<CreDtTm>	ISODateTime	M	Date and time at which the message was created	
<InstgAgt>	Set of elements	M	Instructing agent	The participant BIC shall be indicated in the messages to be sent to the instant payment service. The BIC of Latvijas Banka is indicated in the messages received from the instant payment service.
<FinInstnId>	Set of elements	M		
<BICFI>	4!c2!a2!c	M	BIC of the Instructing Agent	
<InstdAgt>	Set of elements	M	Instructed agent	The BIC of Latvijas Banka shall be indicated in the messages to be sent to the instant payment service. The participant BIC is indicated in the messages received from the instant payment service.
<FinInstnId>	Set of elements	M		
<BICFI>	4!c2!a2!c	M	BIC of the Instructed Agent	
<OrgnlGrpInfAndSts>	Set of elements	M		One occurrence of the element is allowed.
<OrgnlMsgId>	35x	M		Must be used as specified in Paragraph 2.1.2 herein.
<OrgnlMsgNmId>	Code	M	Type of messages in the original bulk	<u>Must begin with Code</u> "pacs.008-001-08" (the addition of a variant number and version number is optional) shall be indicated in the messages to be sent to the instant payment service. <u>In the messages received from the instant payment service Codes may begin with</u> "pacs.008-001-08", "pacs.004-001-09", "pacs.002-001-10", "pacs.028-001-03", "camt.056-001-08" and "camt.029-001-09" are allowed in the messages received from the instant payment service. When forwarding a message received, EKS IP service does not check the correspondence of this value with respect to the version of the original message.
<GrpSts>	Code	C	Bulk status	Code "ACCP" is allowed in the messages to be sent to the instant payment service. Codes "ACCP" or "RJCT" can be indicated in the messages received from the instant payment

					service. Cannot be used at the same time as <TxInfAndSts>/<TxSts>.
	<StsRsnInf>	Set of elements	C	Status reason information	
	<Orgtr>	Set of elements	C	Status originator	Not allowed where <GrpSts> is "ACCP". Mandatory where <GrpSts> is "RJCT".
	<Nm>	70x	C	Name	According to SCT Inst Inter-PSP IG, shall be used where the status information originator is a payment system without the BIC.
	<Id>	Set of elements	C		
	<OrgId>	Set of elements	M		
	<AnyBIC>	4!c2!c2!a[3!c]	M	Status originator BIC	
	<Rsn>	Set of elements	C	Reason for the bulk status	Not allowed where <GrpSts> is "ACCP". Mandatory where <GrpSts> is "RJCT".
	<Cd>	Code	{Or	Reason for the status (ISO20022 error code)	According to SCT Inst Inter-PSP IG, only code "FF01" (erroneous message) is allowed.
	<Prtry>	Code	Or}	Reason for the status (instant payment service error code).	Only code "TECH" (technical problems) is allowed.
	<TxInfAndSts>	Set of elements	M		One occurrence of the element is allowed.
	<StsId>	35x	M	Instant payment status message identifier	Must be used as specified in Paragraph 2.1.2 herein.
	<OrgnlInstrId>	35x	O	Original instruction identification	Must be used as specified in Paragraph 2.1.2 herein.
	<OrgnlEndToEndId>	35x	M	Original identification assigned by the debtor	Must be used as specified in Paragraph 2.1.2 herein.
	<OrgnlTxId>	35x	M	Original message identification	Identifier origin specific for each message type (pacs.008 – <TxId>, pacs.004 – <RtrId>, camt.056 – <CxlId>, camt.029 – <CxlStsId>, pacs.028 – <StsReqId>). If <StsRsnInf>/<Rsn>/<Cd> contains code "AG09" <OrgnlTxId> of pacs.028 message shall be indicated. Must be used as specified in Paragraph 2.1.2 herein.
	<TxSts>	Code	C	Message status	Only code "RJCT" is allowed. cannot be used at the same time as <OrgnlGrpInfAndSts>/<GrpSts>.
	<StsRsnInf>	Set of elements	C	Status reason information	
	<Orgtr>	Set of elements	C	Status originator	Mandatory where <TxSts> is "RJCT".

	<Nm>	70x	C	Status originator name	According to SCT Inst Inter-PSP IG, shall be used where the status information originator is a payment system without the BIC.																																																
	<Id>	Set of elements	C	Identification																																																	
	<OrgId>	Set of elements	C	Organisation identification																																																	
	<AnyBIC>	4!c2!c2!a[3!c]	C	Status originator BIC																																																	
	<Rsn>	Set of elements	C	Reason for the status	Mandatory where <TxSts> is "RJCT".																																																
	<Cd>	Code	{Or	Reason for the status (ISO20022 error code)	<p>Cannot be used at the same time as <Prtry>.</p> <p>Only the following codes are allowed:</p> <table border="1"> <thead> <tr> <th>Code</th> <th>Description</th> <th>OUT*</th> <th>IN*</th> </tr> </thead> <tbody> <tr> <td colspan="4">OUT* – codes indicated in the status report initiated by the participant. IN* – codes indicated in the incoming status message to the participant.</td> </tr> <tr> <td>AB05</td> <td>Instant payment rejected: the creditor agent failed to reply in due time on a possibility to credit the creditor's account.</td> <td>X</td> <td>X</td> </tr> <tr> <td>AB06</td> <td>Instant payment rejected: the intermediary institution failed to reply in due time on a possibility to credit the creditor's account.</td> <td></td> <td>X</td> </tr> <tr> <td>AB07</td> <td>The agent is not available online for receiving instant payments. To be used if it is not known which particular agent is not available.</td> <td></td> <td>X</td> </tr> <tr> <td>AB08</td> <td>Creditor agent is not available online for receiving instant payments.</td> <td>X</td> <td>X</td> </tr> <tr> <td>AB09</td> <td>Instant payment rejected: creditor agent discovered an error in the instant payment.</td> <td>X</td> <td>X</td> </tr> <tr> <td>AB10</td> <td>Instant payment rejected: instant payment system discovered an error in the instant payment.</td> <td></td> <td>X</td> </tr> <tr> <td>AC01</td> <td>Incorrect account number format or the account number does not exist.</td> <td>X</td> <td>X</td> </tr> <tr> <td>AC04</td> <td>The account is closed.</td> <td>X</td> <td>X</td> </tr> <tr> <td>AC06</td> <td>The account is blocked.</td> <td>X</td> <td>X</td> </tr> <tr> <td>AG01</td> <td>Crediting funds to such an account type is not allowed.</td> <td>X</td> <td>X</td> </tr> </tbody> </table>	Code	Description	OUT*	IN*	OUT* – codes indicated in the status report initiated by the participant. IN* – codes indicated in the incoming status message to the participant.				AB05	Instant payment rejected: the creditor agent failed to reply in due time on a possibility to credit the creditor's account.	X	X	AB06	Instant payment rejected: the intermediary institution failed to reply in due time on a possibility to credit the creditor's account.		X	AB07	The agent is not available online for receiving instant payments. To be used if it is not known which particular agent is not available.		X	AB08	Creditor agent is not available online for receiving instant payments.	X	X	AB09	Instant payment rejected: creditor agent discovered an error in the instant payment.	X	X	AB10	Instant payment rejected: instant payment system discovered an error in the instant payment.		X	AC01	Incorrect account number format or the account number does not exist.	X	X	AC04	The account is closed.	X	X	AC06	The account is blocked.	X	X	AG01	Crediting funds to such an account type is not allowed.	X	X
Code	Description	OUT*	IN*																																																		
OUT* – codes indicated in the status report initiated by the participant. IN* – codes indicated in the incoming status message to the participant.																																																					
AB05	Instant payment rejected: the creditor agent failed to reply in due time on a possibility to credit the creditor's account.	X	X																																																		
AB06	Instant payment rejected: the intermediary institution failed to reply in due time on a possibility to credit the creditor's account.		X																																																		
AB07	The agent is not available online for receiving instant payments. To be used if it is not known which particular agent is not available.		X																																																		
AB08	Creditor agent is not available online for receiving instant payments.	X	X																																																		
AB09	Instant payment rejected: creditor agent discovered an error in the instant payment.	X	X																																																		
AB10	Instant payment rejected: instant payment system discovered an error in the instant payment.		X																																																		
AC01	Incorrect account number format or the account number does not exist.	X	X																																																		
AC04	The account is closed.	X	X																																																		
AC06	The account is blocked.	X	X																																																		
AG01	Crediting funds to such an account type is not allowed.	X	X																																																		

					AG02	The bank operation code indicated in the message does not correspond to the creditor.	X	X
					AG09	The original message has not been received.	X	X
					AG10	The agent's operation in the payment system has been suspended.	X	X
					AG11	The creditor agent's operation in the payment system has been suspended.	X	X
					AM02	The instant payment amount exceeds the maximum amount allowed.	X	X
					AM05	Duplicate message	X	X
					BE04	The creditor's address is missing.	X	X
					CNOR	The creditor agent is not a participant of the system.		X
					DNOR	The debtor agent is not a participant of the system.		X
					DT01	A wrong date has been indicated for the instant payment.		X
					MD07	Ultimate creditor has deceased.	X	X
					MS01	Reason not specified	X	X
					MS02	No reason provided by ultimate creditor.	X	X
					MS03	No reason provided by creditor agent.	X	X
					RC01	Wrong BIC		X
					RR01	Instant payment contains no debtor account reference or identification.	X	X
					RR02	Debtor name or address missing in the instant payment.	X	X
					RR03	Creditor name or address missing in the instant payment.	X	X
					RR04	Non-compliance with regulatory requirements.	X	X
					TM01	No reply has been received from the creditor agent within the specified time-frame.	X	X
	<Prtry>	Code	Or}	Reason for the status (clearing service error code)	Used only in messages received from the instant payment service. Cannot be used at the same time as <Cd>. Only the following codes are allowed:			
					AM04	Insufficient instant payment liquidity to execute the instant payment.		
					PY01	BIC missing in the routing table.		
					TECH	Technical problems		
					XT13	Inappropriate XML element		

					<table border="1"> <tr> <td>XT33</td> <td>Incorrect data format</td> </tr> <tr> <td>XT75</td> <td>Incorrect original instant payment status.</td> </tr> <tr> <td>XT90</td> <td>Wrong use of the technical BIC</td> </tr> <tr> <td>C10</td> <td>The received message contains an electronic signature that is wrong, incorrect or revoked by the participant.</td> </tr> <tr> <td>C11</td> <td>The sending participant's electronic signature is missing in the received message.</td> </tr> <tr> <td>C12</td> <td>The message has been signed with an expired key.</td> </tr> </table> <p>Where the message is an instant payment rejection message with code "XT13" or "XT33", the element is compiled as follows: [Code] [space] [erroneous tag].</p>	XT33	Incorrect data format	XT75	Incorrect original instant payment status.	XT90	Wrong use of the technical BIC	C10	The received message contains an electronic signature that is wrong, incorrect or revoked by the participant.	C11	The sending participant's electronic signature is missing in the received message.	C12	The message has been signed with an expired key.
XT33	Incorrect data format																
XT75	Incorrect original instant payment status.																
XT90	Wrong use of the technical BIC																
C10	The received message contains an electronic signature that is wrong, incorrect or revoked by the participant.																
C11	The sending participant's electronic signature is missing in the received message.																
C12	The message has been signed with an expired key.																
	<AcptncDtTm>	ISODateTime	M	Timestamp of original instant payment message acceptance													
	<OrgnlTxRef>	Set of elements	M	Information on the original message													
	<PmtTpInf>	Set of elements	M	Original payment type information													
	<SvcLvl>	Set of elements	M	Service level													
	<Cd>	Code	M	Code	Only code "SEPA" is allowed.												
	<LclInstrm>	Set of elements	M	User community specific instrument information													
	<Cd>	Code	M	Code	Only code "INST" is allowed.												
	<CtgyPurp>	Set of elements	O	Category purpose													
	<Cd>	Code	{Or	Category purpose ISO code	Only ISO 20022 ExternalCategoryPurpose1Code codes are allowed. Cannot be used at the same time as <Prtry>.												
	<Prtry>	35x	Or}	Category purpose code	Cannot be used at the same time as <Cd>.												
	<DbtrAgt>	Set of elements	M	Debtor agent	Debtor agent of the original instant payment.												
	<FinInstnId>	Set of elements	M	Financial institution identification													
	<BICFI>	4!c2!c2!a[3!c]	M	BIC													

5.4.6.4. Instant payment cancellation request message (camt.056.001.08)

An instant payment cancellation request message shall be generated in accordance with ISO 20022 camt.056.001.08 message. An instant payment cancellation request message is sent to the instant payment service participant to inform it about the request to return a previously settled instant payment the details of which are indicated in the message. According to the SEPA Instant Credit Transfer Scheme Rulebook, an instant payment cancellation request message may be submitted to the instant payment service within ten business days following the settlement day of an instant credit transfer (except when instant payment cancellation request is initiated due to fraudulently initiated instant payment, in which case an instant payment cancellation request message may be submitted to the instant payment service within 13 months following the settlement day) where it is initiated by the debtor agent and within 13 months where it is initiated by the debtor. A response to the received instant payment cancellation request, according to the rules stipulated in the SEPA Instant Credit Transfer Scheme Rulebook, shall be sent no later than within fifteen business days, by sending an instant payment return message or a negative response to the instant payment cancellation request message. The instant payment service does not check whether submission deadline is met.

Structure of the message

Element	Format or data type	Status	Description	Notes
└─ <LBFastPmtCxlReq>	Set of elements			
└─ <FIToFIPmtCxlReq>	Set of elements	M		
└─ <Assgnmt>	Set of elements	M	Bulk header	One occurrence of the element is allowed.
└─ <CtrlData>	Set of elements	M	Control data	One occurrence of the element is allowed.
└─ <Undrlyg>	Set of elements	M	Instant payment cancellation request message information	One occurrence of the element is allowed.
└─ <Signature>	Set of elements	M	Signature	One occurrence of the element is allowed.

Bulk header

Element	Format or data type	Status	Description	Notes
└─ <Assgnmt>	Set of elements	M	Bulk header	One occurrence of the element is allowed.
└─ <Id>	35x	M	Instant payment cancellation request message bulk identifier	Must be used as specified in Paragraph 2.1.2 herein.

<Assgnr>	Set of elements	M	Instructing agent of an instant payment cancellation request message	The participant BIC shall be indicated in the <BICFI> element of the messages to be sent to the instant payment service. The BIC of an entity assigning the case shall be indicated in the in the <BICFI> element of the messages received from the instant payment service.
<Pty>	Set of elements	{Or	Party	
<Nm>	70x	{Or	Name	
<Id>	Set of elements	Or}	Identification	
<OrgId>	Set of elements	O	Organisation identification	
<AnyBIC>	4!c2!a2!c[3!c]	{Or	BIC	
<LEI>	18!c2!n	Or}	LEI code	
<Agt>	Set of elements	Or}	Agent	
<FinInstnId>	Set of elements	M	Financial institution identification	
<BICFI>	4!c2!a2!c[3!c]	M	BIC	
<Assgne>	Set of elements	M	Instant payment cancellation request message recipient	The BIC of Latvijas Banka shall be indicated in the messages to be sent to the instant payment service in the <BICFI> element. The participant BIC is indicated in the messages received from the instant payment service in the <BICFI> element.
<Pty>	Set of elements	{Or	Party	
<Nm>	70x	{Or	Name	
<Id>	Set of elements	Or}	Identification	
<OrgId>	Set of elements	O	Organisation identification	
<AnyBIC>	4!c2!a2!c[3!c]	{Or	BIC	
<LEI>	18!c2!n	Or}	LEI code	
<Agt>	Set of elements	Or}	Agent	
<FinInstnId>	Set of elements	M	Financial institution identification	
<BICFI>	4!c2!a2!c[3!c]	M	BIC	
<CreDtTm>	ISODateTime	M	Date and time of bulk creation	

Control data

Element	Format or data type	Status	Description	Notes
<CtrlData>	Set of elements	O	Control data	One occurrence of the element is allowed.
<NbOfTxs>	15n	O	Total number of instant payment cancellations	Only "1" is allowed.

Instant payment cancellation request message information

Element	Format or data type	Status	Description	Notes
<Undrlyg>	Set of elements	M	Copy message to be requested for cancellation	One occurrence of the element is allowed.
<TxInf>	Set of elements	M	Message information	One occurrence of the element is allowed.
<CxlId>	35x	M	Instant payment cancellation request message identifier	Must be used as specified in Paragraph 2.1.2 herein.
<OrgnlGrpInf>	Set of elements	M	Information on the original bulk	
<OrgnlMsgId>	35x	M	Message identifier of the original bulk	Must be used as specified in Paragraph 2.1.2 herein.
<OrgnlMsgNmId>	Code	M	Type of messages in the original bulk	Only code Must begin with "pacs.008.001.08" is allowed. The addition of a variant number and version number is optional. If original pacs.008 was sent before migration to ISO 20022 2019 version, code "pacs.008.001.02" can be used. EKS IP service does not check the correspondence of this value with respect to the version of the original message.
<OrgnlInstrId>	35x	O	Original instruction identification	Must be used as specified in Paragraph 2.1.2 herein.
<OrgnlEndToEndId>	35x	M	Original identification assigned by the debtor	Must be used as specified in Paragraph 2.1.2 herein.
<OrgnlTxId>	35x	M	Original message identification	Must be used as specified in Paragraph 2.1.2 herein.
<OrgnlIntrBkSttlmAmt>	18d EUR	M	Amount of the original message	
<OrgnlIntrBkSttlmDt>	ISODate	M	Value date of the original message	
<CxlRsnInf>	Set of elements	M	Cancellation request reason information	One occurrence of the element is allowed.
<Orgtr>	Set of elements	M	Party originating the request for cancellation	
<Nm>	70x	O	Name of the party originating the request for cancellation originator where its is a debtor	According to SCT Inst Inter-PSP IG, must be indicated if <Cd> contains value "CUST", "AM09" or "AC03".
<Id>	Set of elements	O	Party originating the request for cancellation where it is a debtor agent	
<OrgId>	Set of elements	M	Organisation identification	

	└─ <AnyBIC>	4!c2!a2!c[3!c]	M	The BIC of the party originating the request for cancellation																	
	└─ <Rsn>	Set of elements	M	Cancellation request reason information																	
	└─ <Cd>	Code	{Or	Cancellation reason ISO code	Cannot be used at the same time as <Prtry>. According to SCT Inst Inter-PSP IG the following codes are allowed: <table border="1"> <tr> <td colspan="2">Cancellation is initiated by the debtor</td> </tr> <tr> <td>CUST</td> <td>Beneficiary's refusal</td> </tr> <tr> <td>AC03</td> <td>Wrong IBAN</td> </tr> <tr> <td>AM09</td> <td>Wrong amount</td> </tr> <tr> <td colspan="2">Cancellation is initiated by the debtor agent</td> </tr> <tr> <td>TECH</td> <td>Technical problems</td> </tr> <tr> <td>DUPL</td> <td>Payment is a duplicate of another payment</td> </tr> <tr> <td>FRAD</td> <td>Fraudulent original payment</td> </tr> </table>	Cancellation is initiated by the debtor		CUST	Beneficiary's refusal	AC03	Wrong IBAN	AM09	Wrong amount	Cancellation is initiated by the debtor agent		TECH	Technical problems	DUPL	Payment is a duplicate of another payment	FRAD	Fraudulent original payment
Cancellation is initiated by the debtor																					
CUST	Beneficiary's refusal																				
AC03	Wrong IBAN																				
AM09	Wrong amount																				
Cancellation is initiated by the debtor agent																					
TECH	Technical problems																				
DUPL	Payment is a duplicate of another payment																				
FRAD	Fraudulent original payment																				
	└─ <Prtry>	Code	Or}	Cancellation reason proprietary code	According to SCT Inst Inter-PSP IG, this element can be used only by AOS (Additional Optional Services) participants. Since EKS participants do not use AOS, incoming message containing this element may be rejected.																
	└─ <AddtlInf>	105x	O	Additional Information	One occurrence of the element is allowed. According to SCT Inst Inter-PSP IG, only allowed when <Cd> contains value "CUST", "AC03", "AM09" or "FRAD".																
	└─ <OrgnlTxRef>	Set of elements	M	Information on the original message	According to SCT Inst Inter-PSP IG, sub-elements should contain an exact copy of elements of the received pacs.008. Sub-elements are validated only against xml schema.																
	└─ <IntrBkSttlmDt>	ISODate	O	Value date																	
	└─ <SttlmInf>	Set of elements	O	Settlement Information	Sub-element structure must be aligned with pacs.008.001.08.																
	└─ <SttlmMtd>	Code	O	Settlement method																	
	└─ <SttlmAcct>	Set of elements	O	Settlement Account	Sub-element structure must be aligned with pacs.008.001.08.																
	└─ <ClrSys>	Set of elements	O	Clearing system	Sub-element structure must be aligned with pacs.008.001.08.																
	└─ <PmtTpInf>	Set of elements	O	User community specific instrument information																	
	└─ <SvcLvl>	Set of elements	O	Service Level	Sub-element structure must be aligned with pacs.008.001.08.																

└─ <LclInstrm>	Set of elements	O	User community specific instrument information	Sub-element structure must be aligned with pacs.008.001.08.
└─ <CtgyPurp>	Code	O	Category purpose	Sub-element structure must be aligned with pacs.008.001.08.
└─ <RmtInf>	Set of elements	O	Remittance information	
└─ <Ustrd>	140x	O	Unstructured	
└─ <Strd>	Set of elements	O	Structured	
└─ <UltmtDbtr>	Set of elements	O	Ultimate debtor	
└─ <Pty>	Set of elements	M	Party	
└─ <Nm>	70x	O	Name	
└─ <Id>	Set of elements	M	Ultimate debtor identification	
└─ <OrgId>	Set of elements	{Or	Organisation identification	Sub-element structure must be aligned with pacs.008.001.08.
└─ <PrvtId>	Set of elements	Or}	Fiziskās personas identifikācija	Sub-element structure must be aligned with pacs.008.001.08.
└─ <Dbtr>	Set of elements	O	Debtor	
└─ <Pty>	Set of elements	M	Party	
└─ <Nm>	70x	M	Debtor name	
└─ <PstlAdr>	Set of elements	O	Address	Sub-element structure must be aligned with pacs.008.001.08.
└─ <Id>	Set of elements	O	Debtor identification	
└─ <OrgId>	Set of elements	{Or	Organisation identification	Sub-element structure must be aligned with pacs.008.001.08.
└─ <PrvtId>	Set of elements	Or}	Natural person identification	Sub-element structure must be aligned with pacs.008.001.08.
└─ <DbtrAcct>	Set of elements	M	Debtor account	
└─ <Id>	Set of elements	M	Debtor account identification	
└─ <IBAN>	IBAN	M	IBAN	
└─ <Prxy>	Set of elements	O	Proxy	Sub-element structure must be aligned with pacs.008.001.08.
└─ <DbtrAgt>	Set of elements	M	Debtor agent	The specified BIC shall be available in the routing table.
└─ <FinInstnId>	Set of elements	M	Financial institution identification	
└─ <BICFI>	4!c2!a2!c[3!c]	M	BIC	
└─ <CdtrAgt>	Set of elements	M	Creditor agent	The specified BIC shall be available in the routing table.
└─ <FinInstnId>	Set of elements	M	Financial institution identification	
└─ <BICFI>	4!c2!a2!c[3!c]	M	BIC	
└─ <Cdtr>	Set of elements	O	Creditor	
└─ <Pty>	Set of elements	M	Party	
└─ <Nm>	70x	M	Creditor name	

	┌─ <PstlAdr>	Set of elements	O	Address	Sub-element structure must be aligned with pacs.008.001.08.
	└─ <Id>	Set of elements	O	Creditor identification	
	┌─ <OrgId>	Set of elements	{Or	Organisation identification	Sub-element structure must be aligned with pacs.008.001.08.
	└─ <PrvtId>	Set of elements	Or}	Natural person identification	Sub-element structure must be aligned with pacs.008.001.08.
	┌─ <CdtrAcct>	Set of elements	M	Creditor account	
	└─ <Id>	Set of elements	M	Creditor account identification	
	└─ <IBAN>	IBAN	M	IBAN	
	┌─ <Prxy>	Set of elements	O	Proxy	Sub-element structure must be aligned with pacs.008.001.08.
	┌─ <UltmtCdtr>	Set of elements	O	Ultimate creditor	
	└─ <Pty>	Set of elements	M	Party	
	└─ <Nm>	70x	O	Name	
	└─ <Id>	Set of elements	O	Ultimate creditor identification	
	┌─ <OrgId>	Set of elements	{Or	Organisation identification	Sub-element structure must be aligned with pacs.008.001.08.
	└─ <PrvtId>	Set of elements	Or}	Natural person identification	Sub-element structure must be aligned with pacs.008.001.08.
	┌─ <Purp>	Set of elements	O	Payment purpose	
	└─ <Cd>	Code	M	Payment purpose ISO code	

5.5.6.5 Instant payment resolution of investigation message (camt.029.001.09)

An instant payment resolution of investigation message shall be generated in accordance with ISO 20022 camt.029.001.09 message. An instant payment resolution of investigation message is sent to inform an instant payment service participant that the requested return of the instant payment is not possible.

Structure of the message

Element	Format or data type	Status	Description	Notes
└ <LBFastRsltnOfInvstgtn>	Set of elements			
└└ <RsltnOfInvstgtn>	Set of elements	M		
└└└ <Assgnmt>	Set of elements	M	Instant payment resolution of investigation message bulk information	One occurrence of the element is allowed.
└└└ <Sts>	Set of elements	M	Status data	One occurrence of the element is allowed.
└└└ <CxlDtls>	Set of elements	M	Instant payment resolution of investigation message information	One occurrence of the element is allowed.
└└ <Signature>	Set of elements	M	Signature	One occurrence of the element is allowed.

Bulk header

Element	Format or data type	Status	Description	Notes
└ <Assgnmt>	Set of elements	M		One occurrence of the element is allowed.
└└ <Id>	35x	M	Instant payment resolution of investigation bulk identifier	Must be used as specified in Paragraph 2.1.2 herein.
└└└ <Assgnr>	Set of elements	M	Instructing agent of instant payment resolution of investigation message bulk	The participant BIC shall be indicated in the <BICFI> element of the messages to be sent to the instant payment service. An entity sending the resolution of investigation is indicated in the messages received from the instant payment service.
└└└└ <Pty>	Set of elements	{Or	Party	
└└└└└ <Nm>	70x	{Or	Name	
└└└└└└ <Id>	Set of elements	Or}	Identification	

	<OrgId>	Set of elements	O	Organisation identification	
	<AnyBIC>	4!c2!a2!c[3!c]	{Or	BIC	
	<LEI>	18!c2!n	Or}	LEI code	
	<Agt>	Set of elements	Or}		
	<FinInstnId>	Set of elements	M		
	<BICFI>	4!c2!a2!c[3!c]	M	BIC	
	<Assgne>	Set of elements	M	Instructed agent of an nstant payment resolution of investigation message bulk	The BIC of Latvijas Banka shall be indicated in the <BICFI> element of the messages to be sent to the instant payment service. The participant BIC is indicated in the <BICFI> element of the messages received from the instant payment service.
	<Pty>	Set of elements	O	Party	
	<Nm>	70x	{Or	Name	
	<Id>	Set of elements	Or}	Identification	
	<OrgId>	Set of elements	O	Organisation identification	
	<AnyBIC>	4!c2!a2!c[3!c]	{Or	BIC	
	<LEI>	18!c2!n	Or}	LEI code	
	<Agt>	Set of elements	Or}		
	<FinInstnId>	Set of elements	M		
	<BICFI>	4!c2!a2!c[3!c]	M	BIC	
	<CreDtTm>	ISODateTime	M	Date and time of bulk creation	

Status data

Element	Format or data type	Status	Description	Notes
<Sts>	Set of elements	M		One occurrence of the element is allowed.
<Conf>	Code	M	Resolution of investigation status code	Only code "RJCR" is allowed.

Instant payment resolution of investigation message information

Element	Format or data type	Status	Description	Notes
<CxlDtIs>	Set of elements	M	Instant payment resolution of investigation message information	
<TxInfAndSts>	Set of elements	M	Message information	

<CxlStsId>	35x	M	Instant payment resolution of investigation message identifier	Must be used as specified in Paragraph 2.1.2 herein.
<OrgnlGrpInf>	Set of elements	M	Information on the original bulk	
<OrgnlMsgId>	35x	M	Message identifier of the original bulk	Must be used as specified in Paragraph 2.1.2 herein.
<OrgnlMsgNmId>	Code	M	Type of messages in the original bulk	Only code "pacs.008.001.02" is allowed. The addition of a variant number and version number is optional. If original pacs.008 was sent before migration to ISO 20022 2019 version, code "pacs.008.001.02" can be used. EKS IP service does not check the correspondence of this value with respect to the version of the original message.
<OrgnlInstrId>	35x	O	Original instruction identification	Must be used as specified in Paragraph 2.1.2 herein.
<OrgnlEndToEndId>	35x	M	Original identification assigned by the debtor	Must be used as specified in Paragraph 2.1.2 herein.
<OrgnlTxId>	35x	M	Original message identification	Must be used as specified in Paragraph 2.1.2 herein.
<TxCxlSts>	Code	M	Message cancellation status	Only code "RJCR" is allowed.
<CxlStsRsnInf>	Set of elements	M	resolution of investigation reason information	
<Orgtr>	Set of elements	M	resolution of investigation request originator	
<Nm>	70x	O	Where the originator is a debtor, the name of the debtor originating the resolution of investigation request	According to SCT Inst Inter-PSP IG, cannot be used at the same time as <Id>.
<Id>	Set of elements	O		According to SCT Inst Inter-PSP IG, cannot be used at the same time as <Nm>.
<OrgId>	Set of elements	M		
<AnyBIC>	4!c2!a2!c[3!c]	M	BIC of the resolution of investigation request originator	
<Rsn>	Set of elements	M	Cancellation reason information	
<Cd>	Code	{Or	Cancellation reason code	Cannot be used at the same time as <Prtry>. Only the following codes are allowed:
				CUST Beneficiary's refusal
				LEGL Legal restrictions
				AC04 Account is closed
				AM04 Insufficient funds on the account
				NOAS No response from beneficiary
				NOOR The original instant payment message has not been received

					ARDT	The message has already been returned
	<Prtry>	Code	Or}			Cannot be used at the same time as <Cd>. According to SCT Inst Inter-PSP IG, this element can be used only by AOS (Additional Optional Services) participants. Since EKS participants do not use AOS, incoming message containing this element may be rejected.
	<AddtlInf>	105x	M	Additional information		Multiple occurrences of the element are allowed when the following conditions are met: 1. If used as a negative response to an instant payment cancellation request initiated by the debtor agent, first occurrence is mandatory and must start with the code "ATR053/", followed by the instant payment cancellation request message identifier (field <CxId>) indicated in camt.056. Additionally: 1.1. when "LEGL" is indicated in field <Rsn><Cd>, two further occurrences are allowed to specify the reason of the negative response. Both occurrences shall start with the code "ATR057/"; 1.2. When reason code was "FRAD" in the camt.056, then up to ten further optional occurrences are allowed, all starting with the code "FRAD/" followed by all information available to file a legal claim to recover the funds. 2. If used as a negative response to an instant payment cancellation request initiated by the debtor, first occurrence is mandatory and must start with the code "ATR072/", followed by the instant payment cancellation request message identifier (field <CxId>) indicated in camt.056. Additionally, when reason code was "AC03" in the camt.056, up to ten further optional occurrences are allowed, all starting with the code "ATR078" followed by all information available to file a legal claim to recover the funds transferred to a wrong account number.
	<OrgnlTxRef>	Set of elements	M	Information on the original message		According to SCT Inst Inter-PSP IG, sub-elements should contain an exact copy of elements of the received pacs.008. Sub-elements are validated only against xml schema.
	<IntrBkSttlmDt>	ISODate	O	Amount of the original message		
	<SttlmInf>	Set of elements	O	Value date of the original message		Sub-element structure must be aligned with pacs.008.001.08.
	<SttlmMtd>	Code	O			

└─ <SttlmAcct>	Set of elements	O	Settlement method	Sub-element structure must be aligned with pacs.008.001.08.
└─ <ClrSys>	Set of elements	O		Sub-element structure must be aligned with pacs.008.001.08.
└─ <PmtTpInf>	Set of elements	O		
└─ <SvcLvl>	Set of elements	O		Sub-element structure must be aligned with pacs.008.001.08.
└─ <LclInstrm>	Set of elements	O	User community specific instrument information	Sub-element structure must be aligned with pacs.008.001.08.
└─ <CtgyPurp>	Code	O	Category purpose	Sub-element structure must be aligned with pacs.008.001.08.
└─ <RmtInf>	Set of elements	O	Remittance information	
└─ <Ustrd>	140x	O	Unstructured	
└─ <Strd>	Set of elements	O	Structured	Sub-element structure must be aligned with pacs.008.001.08.
└─ <UltmtDbtr>	Set of elements	O	Ultimate debtor	
└─ <Pty>	Set of elements	M	Party	
└─ <Nm>	70x	O	Name	
└─ <Id>	Set of elements	M	Ultimate debtor identification	
└─ <OrgId>	Set of elements	{Or	Organisation identification	Sub-element structure must be aligned with pacs.008.001.08.
└─ <PrvtId>	Set of elements	Or}	Natural person identification	Sub-element structure must be aligned with pacs.008.001.08.
└─ <Dbtr>	Set of elements	O	Debtor	
└─ <Pty>	Set of elements	M	Party	
└─ <Nm>	70x	M	Debtor name	
└─ <PstlAdr>	Set of elements	O	Address	Sub-element structure must be aligned with pacs.008.001.08.
└─ <Id>	Set of elements	O	Debtor identification	
└─ <OrgId>	Set of elements	{Or	Organisation identification	Sub-element structure must be aligned with pacs.008.001.08.
└─ <PrvtId>	Set of elements	Or}	Natural person identification	Sub-element structure must be aligned with pacs.008.001.08.
└─ <DbtrAcct>	Set of elements	M	Debtor account	
└─ <Id>	Set of elements	M	Debtor account identification	
└─ <IBAN>	IBAN	M	IBAN	
└─ <Prxy>	Set of elements	O	Proxy	Sub-element structure must be aligned with pacs.008.001.08.
└─ <DbtrAgt>	Set of elements	M	Debtor agent	
└─ <FinInstnId>	Set of elements	M	Financial institution identification	

	└─ <BICFI>	4!c2!a2!c[3!c]	M	BIC	
	└─ <CdtrAgt>	Set of elements	M	Creditor agent	
	└─ <FinInstnId>	Set of elements	M	Financial Institution identification	
	└─ <BICFI>	4!c2!a2!c[3!c]	M	BIC	
	└─ <Cdtr>	Set of elements	O	Creditor	
	└─ <Pty>	Set of elements	M	Party	
	└─ <Nm>	70x	M	Creditor name	
	└─ <PstlAdr>	Set of elements	O	Address	Sub-element structure must be aligned with pacs.008.001.08.
				
	└─ <Id>	Set of elements	O	Creditor identification	
	└─ <OrgId>	Set of elements	{Or	Organisation identification	Sub-element structure must be aligned with pacs.008.001.08.
				
	└─ <PrvtId>	Set of elements	Or}	Natural person identification	Sub-element structure must be aligned with pacs.008.001.08.
				
	└─ <CdtrAcct>	Set of elements	M	Creditor account	
	└─ <Id>	Set of elements	M	Creditor account identification	
	└─ <IBAN>	IBAN	M	IBAN	
	└─ <Prxy>	Set of elements	O	Proxy	Sub-element structure must be aligned with pacs.008.001.08.
				
	└─ <UltmtCdtr>	Set of elements	O	Ultimate creditor	
	└─ <Pty>	Set of elements	M	Party	
	└─ <Nm>	70x	O	Name	
	└─ <Id>	Set of elements	O	Ultimate creditor identification	
	└─ <OrgId>	Set of elements	{Or	Organisation identification	Sub-element structure must be aligned with pacs.008.001.08.
				
	└─ <PrvtId>	Set of elements	Or}	Natural person identification	Sub-element structure must be aligned with pacs.008.001.08.
				
	└─ <Purp>	Set of elements	O	Payment purpose	
	└─ <Cd>	Code	M	Payment purpose code	

5-6-6.6 Instant payment status request message (pacs.028.001.03)

An instant payment status request message shall be generated in accordance with ISO 20022 pacs.028.001.03 message. An instant payment status request message shall be sent by a participant where an instant payment status message about an instant payment message sent to the instant payment service has not been received in due time or where an instant payment status message confirming the possibility to credit the account of the creditor in response to the received instant payment message has been sent but an instant payment status message confirming the credit to IP liquidity position has not been received. An instant payment status request message may be sent also to inquire about the status of a previously sent instant payment cancellation request message, where no reply to the instant payment cancellation request message initiated by the debtor has been received within 15 days. The SEPA Instant Credit Transfer Scheme Rulebook approved by the European Payments Council, obliges the creditor agent and the parties involved in the execution of the instant payment to instantly process the instant payment status request message and to respond to it as soon as possible.

Structure of the message

Element	Format or data type	Status	Description	Notes
<Document>	Set of elements			
<FIToFIPmtStsReq>	Set of elements	M		
<GrpHdr>	Set of elements	M	Bulk information	One occurrence of the element is allowed.
<OrgnlGrpInf>	Set of elements	M	Information on the original bulk	One occurrence of the element is allowed.
<TxInf>	Set of elements	M	Message information	One occurrence of the element is allowed.

Bulk header

Element	Format or data type	Status	Description	Notes
<GrpHdr>	Set of elements	M	Instant payment status request message bulk information	One occurrence of the element is allowed.
<MsgId>	35x	M	Bulk identifier	Must be used as specified in Paragraph 2.1.2
<CreDtTm>	ISODatetime	M	Date and time of bulk creation	
<InstgAgt>	Set of elements	M	Instructing agent	The participant BIC shall be indicated in the messages to be sent to the instant payment service. The messages received

					from the instant payment service shall contain the BIC of the institutions that submitted this message to the instant payment service.
	<FinInstnId>	Set of elements	M		
	<BICFI>	4!c2!a2!c[3!c]	M	BIC of the Instructing Agent	
	<InstdAgt>	Set of elements	M	Instructed agent	The BIC of Latvijas Banka shall be indicated in the messages to be sent to the instant payment service. Participant BIC shall be indicated in the messages received from the instant payment service.
	<FinInstnId>	Set of elements	M		
	<BICFI>	4!c2!a2!c[3!c]	M	BIC of the instructed agent	

Information on the original bulk

Element	Format or data type	Status	Description	Notes
<OrgnlGrpInf>	Set of elements	M	Information on the original bulk	One occurrence of the element is allowed.
<OrgnlMsgId>	35x	M	Message identifier of the original bulk	Must be used as specified in Paragraph 2.1.2
<OrgnlMsgNmId>	Code	M	Type of messages in the original bulk	Only codes must begin with "pacs.008.001.08" or "camt.056.001.08". are allowed. If original pacs.008 or camt.056 was sent before migration to ISO 20022 2019 version, code "pacs.008.001.02" or "camt.056.001.01" can be used. The addition of a variant number and version number is optional. EKS IP service does not check the correspondence of this value with respect to the version of the original message.

Status request message structure

Element	Format or data type	Status	Description	Notes
<TxInf>	Set of elements	M		According to SCT Inst Inter-PSP IG, where pacs.028 is being sent to inquire about the status of a previously sent: <ul style="list-style-type: none"> - instant payment message (pacs.008), one occurrence of the element is allowed; - instant payment cancellation request message (camt.056), up several occurrences of the element are allowed in the messages to be sent to the instant

					payment service. The messages received from the instant payment service shall contain one occurrence of the element.
└─	<StsReqId>	35x	M	Message identifier	Must be used as specified in Paragraph 2.1.2 herein.
└─	<OrgnlInstrId>	35x	C	Original instruction identification	Must be used as specified in Paragraph 2.1.2 herein. According to SCT Inst Inter-PSP IG, where <OrgnlMsgNmId> contains value <u>starting with</u> : <ul style="list-style-type: none"> - "camtpacs.008.001.08" or "pacs.008.001.02", mandatory if present in the initial instant payment message; - "camt.056.001.081" or "camt.056.001.01", <CxIIId> of the respective message must be filled in.
└─	<OrgnlEndToEndId>	35x	M	Original identification assigned by the debtor	Must be used as specified in Paragraph 2.1.2 herein.
└─	<OrgnlTxId>	35x	M	Original message identification	Must be used as specified in Paragraph 2.1.2 herein.
└─	<AcceptncDtTm>	ISODateTIme	O	Timestamp of original instant payment message acceptance	According to SCT Inst Inter-PSP IG, if <OrgnlMsgNmId> contains value <u>starting with</u> : <ul style="list-style-type: none"> - "pacs.camt.008.001.08" or "pacs.008.001.02", mandatory; - "camt.056.001.08" or "camt.056.001.01", timestamp of original instant payment message (pacs.008) acceptance must be filled in.
└─	<OrgnlTxRef>	Set of elements	M	Information on the original message	According to SCT Inter-PSP IG, sub-elements should contain an exact copy of elements of the received pacs.008. Sub-elements are validated only against xml schema.
└─	<IntrBkSttlmDt>	ISODate	O	Amount of the original message	
└─	<SttlmInf>	Set of elements	O	Date of the original message	Sub-element structure must be aligned with pacs.008.001.08.
└─	<SttlmMtd>	Kods	O		
└─	<SttlmAcct>	Set of elements	O	Settlement method	Sub-element structure must be aligned with pacs.008.001.08.
└─	<ClrSys>	Set of elements	O		Sub-element structure must be aligned with pacs.008.001.08.
└─	<PmtTpInf>	Set of elements	O	Payment type information	
└─	<SvcLvl>	Set of elements	O	Service level	Sub-element structure must be aligned with pacs.008.001.08.

└─ <LclInstrm>	Set of elements	O	User community specific instrument information	Sub-element structure must be aligned with pacs.008.001.08.
└─ <CtgyPurp>	Kods	O	Category purpose	Sub-element structure must be aligned with pacs.008.001.08.
└─ <RmtInf>	Set of elements	O	Remittance information	
└─ <Ustrd>	140x	O	Unstructured	
└─ <Strd>	Set of elements	O	Structured	Sub-element structure must be aligned with pacs.008.001.08.
└─ <UltmtDbtr>	Set of elements	O	Ultimate debtor	
└─ <Pty>	Set of elements	M	Party	
└─ <Nm>	70x	O	Ultimate debtor's name	
└─ <Id>	Set of elements	M	Ultimate debtor identifier	
└─ <OrgId>	Set of elements	{Or	Organisation identification	Sub-element structure must be aligned with pacs.008.001.08.
└─ <PrvtId>	Set of elements	Or}	Natural person identification	Sub-element structure must be aligned with pacs.008.001.08.
└─ <Dbtr>	Set of elements	O	Debtor	
└─ <Pty>	Set of elements	M	Party	
└─ <Nm>	70x	M	Debtor name	
└─ <PstlAdr>	Set of elements	O	Address	Sub-element structure must be aligned with pacs.008.001.08.
└─ <Id>	Set of elements	O	Debtor identification	
└─ <OrgId>	Set of elements	{Or	Organisation identification	Sub-element structure must be aligned with pacs.008.001.08.
└─ <PrvtId>	Set of elements	Or}	Natural person identification	Sub-element structure must be aligned with pacs.008.001.08.
└─ <DbtrAcct>	Set of elements	O	Debtor account	
└─ <Id>	Set of elements	O	Debtor account identification	
└─ <IBAN>	IBAN	O	IBAN	
└─ <Prxy>	Set of elements	O	Proxy	Sub-element structure must be aligned with pacs.008.001.08.
└─ <DbtrAgt>	Set of elements	M	Debtor agent	
└─ <FinInstnId>	Set of elements	M	Financial institution identification	
└─ <BICFI>	4!c2!a2!c[3!c]	M	BIC	
└─ <CdtrAgt>	Set of elements	M	Creditor agent	
└─ <FinInstnId>	Set of elements	M	Financial institution identification	
└─ <BICFI>	4!c2!a2!c[3!c]	M	BIC	Mandatory in the messages to be sent to the instant payment service.
└─ <Cdtr>	Set of elements	O	Creditor	

	<Pty>	Set of elements	M	Party	Sub-element structure must be aligned with pacs.008.001.08.
	├─ <Nm>	70x	M	Creditor name	
	└─ <PstlAdr>	Set of elements	O	Address	
				
	├─ <Id>	Set of elements	O	Creditor identification	
	└─ <OrgId>	Set of elements	{Or	Organisation identification	
				
	└─ <PrvtId>	Set of elements	Or}	Natural person identification	
				
	<CdtrAcct>	Set of elements	O	Creditor account	
	├─ <Id>	Set of elements	O	Creditor account identification	
	├─ <IBAN>	IBAN	O	IBAN	
	└─ <Prxy>	Set of elements	O	Proxy	Sub-element structure must be aligned with pacs.008.001.08.
				
	<UltmtCdtr>	Set of elements	O	Ultimate creditor	
	├─ <Pty>	Set of elements	M	Party	
	├─ <Nm>	70x	O	Ultimate creditor's 'ame	
	├─ <Id>	Set of elements	O	Ultimate creditor identification	
	└─ <OrgId>	Set of elements	{Or	Organisation identification	Sub-element structure must be aligned with pacs.008.001.08.
				
	└─ <PrvtId>	Set of elements	Or}	Natural person identification	Sub-element structure must be aligned with pacs.008.001.08.
				
	<Purp>	Set of elements	O	Payment purpose	
	<Cd>	Kods	M	Payment purpose code	

5.7.6.7. Reply message to an incoming message not compliant with the scheme

Where a message that is not compliant with the message scheme has been received from a participant, a rejection message is sent in reply to this erroneous message informing that the message cannot be processed.

No.	Element	Format or data type	Status	Description
1.	<FastCrptMsg>	Set of elements	M	
2.	<MsgId>	35x	M	Message identifier. Space is not allowed.
3.	<RelMsgId>	35x	M	Identifier of the incoming message which the current message replies to. Space is not allowed.
4.	<CreDtTm>	ISODateTime	M	Date and time of message creation.
5	<MsgErrCode>	Kods	M	Only value "INVSCHEMA".

5.8.6.8. Technical maintenance message

If any of the instant payment service participants has notified Latvijas Banka of technical maintenance in relation to its registered BIC, the instant payment service shall send a technical maintenance message to all participants in accordance with ISO 20022 admi.004.001.02 message.

No.	Element	Format or data type	Status	Description
1	<SysEvtNtfctn>	Set of elements	M	
2	<EvtInf>	Set of elements	M	Detailed information about an event.
3	<EvtCd>	Code	M	The following codes are used: "INS" – for insertion of a new technical maintenance message; "DEL" – for deleting of a previous inserted technical maintenance message.
4	<EvtParam>	35x	M	Event Parameter. Five occurrences are used: 1. unique message identifier; 2. BIC8 or BIC11 of an entity having technical maintenance; 3. Start of technical maintenance in ISODateTime format; 4. End of technical maintenance in ISODateTime format; 5. code "YES".
5	<EvtDesc>	1000x	O	Event description.
6	<EvtTm>	ISODateTime	M	Date and time of message creation in ISODateTime format.

5.9.6.9. Double-entry check

Double-entry check shall be performed by the instant payment service for the following message elements.

No.	Message type	Transaction identification	Sending institution	Date part from the the message field
1.	pacs.008	<TxId>	<DbtrAgt>	<AcceptncDtTm>
2.	pacs.004	<RtrId>	<CdtrAgt>	<IntrBkSttlmDt>
3.	camt.056	<CxlId>	<DbtrAgt>	<CreDtTm>
4.	camt.029	<CxlStsId>	<CdtrAgt>	<CreDtTm>
5.	pacs.028	<StsReqId>	<DbtrAgt>	<CreDtTm>

Where the information of a newly submitted message to be checked is identical to the information of the message that has already been processed, the newly submitted message shall be rejected.

Double-entry check shall not be performed for instant payment status messages (pacs.002). Where the instant payment service receives more than one instant payment status message related to the same instant payment message, payment status shall be updated only based on the first message received, while following messages are forwarded without changing the status of an instant payment.

6.7. Management of instant payment liquidity position

A participant must ensure sufficient current IP liquidity position for executing its instant payments and instant payment returns. To manage the position, a participant that is a participant in TARGET may use the option to automatically increase and decrease the instant payment liquidity by setting up the parameters for an automatic increase and decrease of instant payment liquidity using the instant payment service workstation. All participants can make use of warning messages sent by the instant payment service if the current IP liquidity position for the registered BIC of the participant falls below the limit pre-set by the participant. Instant payment service shall perform checks on whether IP liquidity position has reached parameters set by the participant each 15 (fifteen) minutes.

6.1.7.1. Current IP liquidity position request message (camt.060)

A participant can monitor the current IP liquidity position for each of its registered BIC by using the instant payment service workstation or by sending a current IP liquidity position request message. Latvijas Banka shall provide a participant's candidate the instant payment service workstation user guide when it prepares to connect to Latvijas Banka's Information System for Monitoring Customer Accounts, while for participants the current version of the user guide is available in the workstation.

The participant shall generate the current IP liquidity position request message in accordance with ISO 20022 camt.060 XML message and send it to the instant payment service.

Element	Format or data type	Status	Description
<GrpHdr>	Set of elements	M	
<MsgId>	35x	M	Message identifier. Space is not allowed.
<CreDtTm>	ISODateTime	M	Date and time of message creation.
<RptgReq>	Set of elements	M	
<ReqdMsgNmId>	35x	M	Requested message type; only code "camt.052" is allowed.
<AcctOwnr>	Set of elements	M	IP cover account owner.
<Agt>	Set of elements	M	
<FinInstnId>	Set of elements	M	
<BICFI>	4!c2!a2!c	M	Registered BIC.

6.2.7.2. Liquidity transfer order to increase current IP liquidity position sent by the participant that is a participant in TARGET

Liquidity transfer order to increase the current IP liquidity position is sent with the purpose of increasing the current IP liquidity position for the registered BIC of the participant. A participant may input an instruction in instant payment service workstation or prepare it as a SWIFT MT298 format message and send it to Latvijas Banka via SWIFT FIN communication channels. In the SWIFT MT298 format message in the field :12: message subtype "702" shall be indicated and in Field :77E: code "/FASTEKS/INCCOV/" shall be indicated, followed by the amount (in format 15d) for which the current IP liquidity position should be increased.

Example:

:12:702

:77E:/FASTEKS/INCCOV/50000

6.3.7.3.Payment to increase the IP liquidity position sent by the participant that is not a participant in TARGET

To increase the IP liquidity position a participant sends a credit transfer, instant payment or customer payment in TARGET from the account specified in the participant's application form for the static data registration and opened in the European Economic Area country established credit institution or in its own books.

6.4.7.4.Liquidity transfer order to decrease current IP liquidity position

Liquidity transfer order to decrease the current IP liquidity position is sent with the purpose of decreasing the current IP liquidity position for the registered BIC of the participant. A participant may input an instruction in instant payment service workstation or prepare it as a SWIFT MT298 format message and send it to Latvijas Banka via SWIFT FIN communication channels. In the SWIFT MT298 format message in the field :12: message subtype "703" shall be indicated and in Field :77E: code "/FASTEKS/DECCOV/" shall be indicated, followed by the amount (in format 15d) for which the current IP liquidity position should be decreased.

Example:

```
:12:703
:77E:/FASTEKS/DECCOV/50000
```

6.5.7.5.Notification of rejection of liquidity transfer order to increase/decrease current IP liquidity position

If the liquidity transfer order to increase/decrease current IP liquidity position cannot be processed, Latvijas Banka shall reject it and inform the participant about the rejection in instant payment service workstation. If the liquidity transfer order has been sent as a SWIFT MT298 format message, Latvijas Banka shall inform the participant about the rejection also by sending a SWIFT MT298 format message. In the SWIFT MT298 format message in the field :77E: code "/FASTEKS/" shall be indicated, followed by the reference of the request and in the field :12: the subtype of the message shall be indicated: "712" - if the balance of the relevant account is not sufficient to execute the request or "711" - if the request has been incorrectly generated.

Example:

```
:12:712
:77E:/FASTEKS/REFERENCE123
```

6.6.7.6.Current IP liquidity position message (camt.052)

The instant payment service shall generate a current IP liquidity position message in accordance with ISO 20022 camt.052.001.08 XML message and send it to the participant, using its registered BIC code:

- a) as a reply to the received current IP liquidity position request message;
- b) if the current IP liquidity position for the registered BIC of the participant falls below the limit pre-set by the participant and the participant, using the instant payment service's workstation, has chosen to receive a message to that effect. Such a message is sent at the moment when the current IP liquidity position for the registered BIC of the participant

falls below the limit pre-set by the participant as well as every 15 minutes after that as long as the current IP liquidity position still remains below that limit.

Element	Format or data type	Status	Description
└─ <BkToCstmr AccRpt>	Set of elements	M	
└─ <GrpHdr>	Set of elements	M	
└─ <MsgId>	35x	M	Message identifier. Space is not allowed.
└─ <CreDtTm>	ISODateTime	M	Date and time of message creation.
└─ <OrgnlBizQry>	Set of elements	M	
└─ <MsgId>	35x	M	Identifier of the message which the current message replies to. Shall contain the value "BELOWLIMIT" if the instant payment service has generated a message to inform that the current IP liquidity position has fallen below the limit.
└─ <Rpt>	Set of elements	M	
└─ <Id>	35x	M	Report identifier.
└─ <CreDtTm>	ISODateTime	M	Date and time of report creation.
└─ <Acct>	Set of elements	M	Account information.
└─ <Id>	Set of elements	M	Account identifier.
└─ <Othr>	Set of elements	M	
└─ <Id>	35x	M	IP cover account number.
└─ <Ownr>	Set of elements	M	Account owner.
└─ <Id>	Set of elements	M	Identification of the account owner.
└─ <OrgId>	Set of elements	M	
└─ <AnyBIC>	4!c2!a2!c[3!c]	M	Registered BIC of the participant.
└─ <Bal>	Set of elements	M	Account balance information.
└─ <Tp>	Set of elements	M	Account balance type.
└─ <CdOrPrtry>	Set of elements	M	
└─ <Cd>	4!a	M	Account balance type code. Code "ITAV" is used – current IP liquidity position that may change during the day.
└─ <Amt>	18d EUR	M	Current IP liquidity position.
└─ <CdtDbtInd>	4!a	M	Code "CRDT" is used.
└─ <Dt>	Set of elements	M	
└─ <DtTm>	ISODateTime	M	Date and time when current IP liquidity position was recorded.

6.7.7.7. IP liquidity position credit/debit notification (camt.054)

The instant payment service shall generate an IP liquidity position credit/debit notification message in accordance with ISO 20022 camt.054.001.08 XML message and send it to the participant, using its registered BIC code, to notify the participant on the changes in its IP liquidity position that took place as a result of:

- execution of participant's liquidity transfer order to decrease or increase its current IP liquidity position;
- balancing of the initial IP liquidity position (only to the participant that is a participant in TARGET).

Element	Format or data type	Status	Description
└─ <BkToCstmrDbtCdt Ntfctn>	Set of elements	M	
└─ <GrpHdr>	Set of elements	M	

<MsgId>	35x	M	Message identifier. Space is not allowed.
<CreDtTm>	ISODateTime	M	Date and time of message creation.
<Ntfctn>	Set of elements	M	Notification information.
<Id>	35x	M	Notification identifier.
<CreDtTm>	ISODateTime	M	Date and time of notification creation.
<Acct>	Set of elements	M	Account information.
<Id>	Set of elements	M	Account identifier.
<Othr>	Set of elements	M	
<Id>	34x	M	IP cover account number.
<Ntry>	Set of elements	M	Set of elements used to specify an entry in the notification.
<NtryRef>	35x	M	Entry reference.
<Amt>	18d EUR	M	Amount.
<CdtDbtInd>	4!a	M	Indicates whether the entry is a credit or a debit entry. Code "CRDT" is used to indicate a credit entry, code "DBIT" is used to indicate a debit entry.
<Sts>	Set of elements	M	Entry status.
<Cd>	4!a	M	Entry status code. Code "BOOK" is used.
<BookgDt>	Set of elements	M	
<DtTm>	ISODateTime	M	Date and time when an entry is posted to an account.
<BkTxCd>	Set of elements	M	Set of elements used to identify the type of underlying transaction resulting in an entry.
<Domn>	Set of elements	M	
<Cd>	4!a	M	Only ISO 20022 codes are allowed (Table 1).
<Fmly>	Set of elements	M	
<Cd>	4!a	M	Only ISO 20022 codes are allowed (Table 2).
<SubFmlyCd>	4!a	M	Only ISO 20022 codes are allowed (Table 3).
<NtryDtls>	Set of elements	M	Set of elements used to provide details on the entry.
<TxDtls>	Set of elements	M	
<RltdPties>	Set of elements	M	Related parties.
<Dbtr>	Set of elements	M	Debtor.
<Pty>	Set of elements	M	
<Id>	Set of elements	M	
<OrgId>	Set of elements	M	
<AnyBIC>	4!c2!a2!c[3!c]	M	BIC of the debtor.
<DbtrAcct>	Set of elements	M	Debtor account.
<Id>	Set of elements	M	
<Othr>	Set of elements	M	
<Id>	34x	M	Account number.
<Cdtr>	Set of elements	M	Creditor.
<Pty>	Set of elements	M	
<Id>	Set of elements	M	
<OrgId>	Set of elements	M	
<AnyBIC>	4!c2!a2!c[3!c]	M	BIC of the creditor.

<CdtrAcct>	Set of elements	M	Creditor account.
<Id>	Set of elements	M	
<Othr>	Set of elements	M	
<Id>	34x	M	Account number.

6.8.7.8. Statement of IP cover account (camt.053)

The statement of IP cover account shall be generated every TARGET business day in accordance with ISO 20022 camt.053.001.08 message.

Element	Format or data type	Status	Description
<BkToCstmrStmnt>	Set of elements	M	
<GrpHdr>	Set of elements	M	
<MsgId>	35x	M	Message identifier. Space is not allowed.
<CreDtTm>	ISODateTime	M	Date and time of message creation.
<MsgPgntn>	Set of elements	M	Set of elements used to provide details on the page number of the message.
<PgNb>	5x	M	Page number.
<LastPgInd>	4!a	M	Indicates whether the current page of the statement is the last page. Code "true" is used to indicate the last page, otherwise code "false" is used.
<Stmnt>	Set of elements	M	Set of elements used to provide details on the statement.
<Id>	35x	M	Statement identifier.
<CreDtTm>	ISODateTime	M	Date and time of statement creation.
<FrToDt>	Set of elements	M	Range of time between a start of a period and an end of a period for which the account statement is issued.
<FrDtTm>	ISODateTime	M	Date and time when statement period starts.
<ToDtTm>	ISODateTime	M	Date and time when statement period ends.
<Acct>	Set of elements	M	Account information.
<Id>	Set of elements	M	Account identifier.
<Othr>	Set of elements	M	
<Id>	34x	M	IP cover account number.
<Ownr>	Set of elements	M	Account owner information.
<Id>	Set of elements	M	Account owner identifier.
<OrgId>	Set of elements	M	
<AnyBIC>	4!c2!a2!c[3!c]	M	Registered BIC of the participant.
<Bal>	Set of elements	M	Set of elements used to define the balance. Two sequences are used – to indicate the balance at the start of the reporting period and at the end of the reporting period.

	<Tp>	Set of elements	M	Specifies the nature of a balance.
	<CdOrPrtry>	Set of elements	M	
	<Cd>	4!a	M	Balance type code. Code "OPBD" is used to indicate the opening balance, code "CLBD" is used to indicate the closing balance.
	<SubTp>	Set of elements	C	Balance subtype is used for paginated messages.
	<Cd>	4!a	M	Code "INTM" is used along with code "OPBD" or "CLBD" in the field <Tp>/<CdOrPrtry>/<Cd>, and indicates the intermediate characteristic of the respective balance.
	<Amt>	18d EUR	M	IP cover account balance.
	<CdtDbtInd>	4!a	M	Code "CRDT" is used to indicate a credit position.
	<Dt>	Set of elements	M	
	<Dt>	ISODate	M	Date when the balance was recorded.
	<TxSummary>	Set of elements	M	Summary on entries included in the statement.
	<TtlNtriesPer BkTxCd>	Set of elements	M	Specifies the total number and sum of entries per bank transaction code.
	<CdtNtries>	Set of elements	M	Information on credit entries. Is indicated for the following transaction types (code in the field <Domn>/<Cd>/ code in the field <Fmly>/<Cd>/ code in the field <SubFmlyCd>): 1) PMNT/RRCT/ESCT; 2) PMNT/RRCT/RRTN; 3) CAMT/ACCB/TOPG.
	<NbOfNtries>	15n	M	Number of credit entries. If there have been no transactions of the respective type on the reporting date, zero "0" is indicated.
	<Sum>	18d EUR	M	Sum of credit entries. If there have been no transactions of the respective type on the reporting date, zero "0" is indicated.
	<DbtNtries>	Set of elements	M	Information on debit entries. Is indicated for the following transaction types (code in the field <Domn>/<Cd>/ code in the field <Fmly>/<Cd>/ code in the field <SubFmlyCd>): 1) PMNT/IRCT/ESCT; 2) PMNT/IRCT/RRTN; 3) CAMT/ACCB/SWEP.

	<NbOfNtries>	15n	M	Number of debit entries. If there have been no transactions of the respective type on the reporting date, zero "0" is indicated.										
	<Sum>	18d EUR	M	Sum of debit entries. If there have been no transactions of the respective type on the reporting date, zero "0" is indicated.										
	<BkTxCd>	Set of elements	M	Set of elements used to fully identify the type of underlying transaction resulting in an entry.										
	<Domn>	Set of elements	M											
	<Cd>	4!a	M	Only following ISO 20022 codes are allowed <table border="1"> <thead> <tr> <th>Code</th> <th>Explanation</th> </tr> </thead> <tbody> <tr> <td>PMNT</td> <td>Instant payment (pacs.008) and instant payment return (pacs.004).</td> </tr> <tr> <td>CAMT</td> <td>Increase or decrease in the current IP liquidity position as a result of a liquidity transfer.</td> </tr> </tbody> </table>	Code	Explanation	PMNT	Instant payment (pacs.008) and instant payment return (pacs.004).	CAMT	Increase or decrease in the current IP liquidity position as a result of a liquidity transfer.				
Code	Explanation													
PMNT	Instant payment (pacs.008) and instant payment return (pacs.004).													
CAMT	Increase or decrease in the current IP liquidity position as a result of a liquidity transfer.													
	<Fmly>	Set of elements	M											
	<Cd>	4!a	M	Only following ISO 20022 codes are allowed. <table border="1"> <thead> <tr> <th>Code</th> <th>Explanation</th> </tr> </thead> <tbody> <tr> <td>RRCT</td> <td>Received instant payment (pacs.008) and instant payment return (pacs.004).</td> </tr> <tr> <td>IRCT</td> <td>Sent instant payment (pacs.008) and instant payment return (pacs.004).</td> </tr> <tr> <td>ACCB</td> <td>Increase or decrease in the current IP liquidity position as a result of a liquidity transfer.</td> </tr> </tbody> </table>	Code	Explanation	RRCT	Received instant payment (pacs.008) and instant payment return (pacs.004).	IRCT	Sent instant payment (pacs.008) and instant payment return (pacs.004).	ACCB	Increase or decrease in the current IP liquidity position as a result of a liquidity transfer.		
Code	Explanation													
RRCT	Received instant payment (pacs.008) and instant payment return (pacs.004).													
IRCT	Sent instant payment (pacs.008) and instant payment return (pacs.004).													
ACCB	Increase or decrease in the current IP liquidity position as a result of a liquidity transfer.													
	<SubFmly Cd>	4!a	M	Only following ISO 20022 codes are allowed. <table border="1"> <thead> <tr> <th>Code</th> <th>Explanation</th> </tr> </thead> <tbody> <tr> <td>ESCT</td> <td>Instant payment.</td> </tr> <tr> <td>RRTN</td> <td>Instant payment return.</td> </tr> <tr> <td>SWEP</td> <td>Decrease in the current IP liquidity position as a result of a liquidity transfer.</td> </tr> <tr> <td>TOPG</td> <td>Increase in the current IP liquidity position as a result of a liquidity transfer.</td> </tr> </tbody> </table>	Code	Explanation	ESCT	Instant payment.	RRTN	Instant payment return.	SWEP	Decrease in the current IP liquidity position as a result of a liquidity transfer.	TOPG	Increase in the current IP liquidity position as a result of a liquidity transfer.
Code	Explanation													
ESCT	Instant payment.													
RRTN	Instant payment return.													
SWEP	Decrease in the current IP liquidity position as a result of a liquidity transfer.													
TOPG	Increase in the current IP liquidity position as a result of a liquidity transfer.													
	<Ntry>	Set of elements	C	Set of elements used to specify an entry in the statement.										
	<NtryRef>	35x	M	Entry reference.										
	<Amt>	18d EUR	M	Amount.										
	<CdtDbtInd>	4!a	M	Indicates whether the entry is a credit or a debit entry. Code "CRDT" is used to indicate a credit entry, code "DBIT" is used to indicate a debit entry.										
	<Sts>	Set of elements	M	Entry status.										
	<Cd>	4!a	M	Entry status code. Code "BOOK" is used.										

	<BookgDt>	Set of elements	M											
	<DtTm>	ISODateTime	M	Date and time when an entry is posted to an account.										
	<BkTxCd>	Set of elements	M	Set of elements used to identify the type of underlying transaction resulting in an entry.										
	<Domn>	Set of elements	M											
	<Cd>	4!a	M	Only following ISO 20022 codes are allowed <table border="1"> <thead> <tr> <th>Code</th> <th>Explanation</th> </tr> </thead> <tbody> <tr> <td>PMNT</td> <td>Instant payment (pacs.008) and instant payment return (pacs.004).</td> </tr> <tr> <td>CAMT</td> <td>Increase or decrease in the current IP liquidity position as a result of a liquidity transfer.</td> </tr> </tbody> </table>	Code	Explanation	PMNT	Instant payment (pacs.008) and instant payment return (pacs.004).	CAMT	Increase or decrease in the current IP liquidity position as a result of a liquidity transfer.				
Code	Explanation													
PMNT	Instant payment (pacs.008) and instant payment return (pacs.004).													
CAMT	Increase or decrease in the current IP liquidity position as a result of a liquidity transfer.													
	<Fmly>	Set of elements	M											
	<Cd>	4!a	M	Only following ISO 20022 codes are allowed. <table border="1"> <thead> <tr> <th>Code</th> <th>Explanation</th> </tr> </thead> <tbody> <tr> <td>RRCT</td> <td>Received instant payment (pacs.008) and instant payment return (pacs.004).</td> </tr> <tr> <td>IRCT</td> <td>Sent instant payment (pacs.008) and instant payment return (pacs.004).</td> </tr> <tr> <td>ACCB</td> <td>Increase or decrease in the current IP liquidity position as a result of a liquidity transfer.</td> </tr> </tbody> </table>	Code	Explanation	RRCT	Received instant payment (pacs.008) and instant payment return (pacs.004).	IRCT	Sent instant payment (pacs.008) and instant payment return (pacs.004).	ACCB	Increase or decrease in the current IP liquidity position as a result of a liquidity transfer.		
Code	Explanation													
RRCT	Received instant payment (pacs.008) and instant payment return (pacs.004).													
IRCT	Sent instant payment (pacs.008) and instant payment return (pacs.004).													
ACCB	Increase or decrease in the current IP liquidity position as a result of a liquidity transfer.													
	<SubFmlyCd>	4!a	M	Only following ISO 20022 codes are allowed. <table border="1"> <thead> <tr> <th>Code</th> <th>Explanation</th> </tr> </thead> <tbody> <tr> <td>ESCT</td> <td>Instant payment.</td> </tr> <tr> <td>RRTN</td> <td>Instant payment return.</td> </tr> <tr> <td>SWEP</td> <td>Decrease in the current IP liquidity position as a result of a liquidity transfer.</td> </tr> <tr> <td>TOPG</td> <td>Increase in the current IP liquidity position as a result of a liquidity transfer.</td> </tr> </tbody> </table>	Code	Explanation	ESCT	Instant payment.	RRTN	Instant payment return.	SWEP	Decrease in the current IP liquidity position as a result of a liquidity transfer.	TOPG	Increase in the current IP liquidity position as a result of a liquidity transfer.
Code	Explanation													
ESCT	Instant payment.													
RRTN	Instant payment return.													
SWEP	Decrease in the current IP liquidity position as a result of a liquidity transfer.													
TOPG	Increase in the current IP liquidity position as a result of a liquidity transfer.													
	<NtryDtls>	Set of elements	M	Set of elements used to provide details on the entry.										
	<TxDtls>	Set of elements	M											
	<RltdAgts>	Set of elements	M											
	<DbtrAgt>	Set of elements	M	Debtor agent.										
	<FinInstnId>	Set of elements	M											
	<BICFI>	4!c2!a2!c[3!c]	M	BIC of the debtor agent.										
	<CdtrAgt>	Set of elements	M	Creditor agent.										
	<FinInstnId>	Set of elements	M											
	<BICFI>	4!c2!a2!c[3!c]	M	BIC of the creditor agent.										
	<RltdDts>	Set of elements	C	Used, when <Domn>/<Cd> contains code "PMNT".										

<AcctncDtTm>	ISODateTime	C	Used, when <SubFmlyCd> contains code "ESCT".
<IntrBkSttlmDt>	ISODate	C	Used, when <SubFmlyCd> contains code "RRTN".

6.9.7.9. IP liquidity position report (camt.052)

The IP liquidity position report shall be generated every calendar day in accordance with ISO 20022 camt.052.001.08 message.

Element	Format or data type	Status	Description
<BkToCstmrAcctRpt>	Set of elements	M	
<GrpHdr>	Set of elements	M	
<MsgId>	35x	M	Message identifier. Space is not allowed.
<CreDtTm>	ISODateTime	M	Date and time of message creation.
<MsgPgntn>	Set of elements	M	Set of elements used to provide details on the page number of the message.
<PgNb>	5x	M	Page number.
<LastPgInd>	4!a	M	Indicates whether the current page of the report is the last page. Code "true" is used to indicate the last page, otherwise code "false" is used.
<Rpt>	Set of elements	M	Set of elements used to provide details on the report.
<Id>	35x	M	Report identifier.
<CreDtTm>	ISODateTime	M	Date and time of report creation.
<FrToDt>	Set of elements	M	Range of time between a start of a period and an end of a period for which the report is issued.
<FrDtTm>	ISODateTime	M	Date and time when report period starts.
<ToDtTm>	ISODateTime	M	Date and time when report period ends.
<Acct>	Set of elements	M	Account information.
<Id>	Set of elements	M	Account identifier.
<Othr>	Set of elements	M	
<Id>	34x	M	IP cover account number.
<Ownr>	Set of elements	M	Account owner information.
<Id>	Set of elements	M	Account owner identifier.
<OrgId>	Set of elements	M	
<AnyBIC>	4!c2!a2!c[3!c]	M	Registered BIC of the participant.
<Bal>	Set of elements	M	Set of elements used to define the balance. Two sequences are used – to indicate the balance at the start of the reporting period and at the end of the reporting period.

	<Tp>	Set of elements	M	Specifies the nature of a balance.
	<CdOrPrtry>	Set of elements	M	
	<Cd>	4!a	M	Balance type code. Code "OPBD" is used to indicate the opening balance, code "CLBD" is used to indicate the closing balance.
	<SubTp>	Set of elements	C	Balance subtype is used for paginated messages.
	<Cd>	4!a	M	Code "INTM" is used along with code "OPBD" or "CLBD" in the field <Tp>/<CdOrPrtry>/<Cd>, and indicates the intermediate characteristic of the respective balance.
	<Amt>	18d EUR	M	IP cover account balance.
	<CdtDbtInd>	4!a	M	Code "CRDT" is used to indicate a credit position.
	<Dt>	Set of elements	M	
	<Dt>	ISODate	M	Date when the balance was recorded.
	<TxSummary>	Set of elements	M	Summary on entries included in the statement.
	<TtlNtriesPer BkTxCd>	Set of elements	M	Specifies the total number and sum of entries per bank transaction code.
	<CdtNtries>	Set of elements	M	Information on credit entries. Is indicated for the following transaction types (code in the field <Domn>/<Cd>/ code in the field <Fmly>/<Cd>/ code in the field <SubFmlyCd>): 1) PMNT/RRCT/ESCT; 2) PMNT/RRCT/RRTN; 3) CAMT/ACCB/TOPG.
	<NbOfNtries>	15n	M	Number of credit entries. If there have been no transactions of the respective type on the reporting date, zero "0" is indicated.
	<Sum>	18d EUR	M	Sum of credit entries. If there have been no transactions of the respective type on the reporting date, zero "0" is indicated.
	<DbtNtries>	Set of elements	M	Information on debit entries. Is indicated for the following transaction types (code in the field <Domn>/<Cd>/ code in the field <Fmly>/<Cd>/ code in the field <SubFmlyCd>): 1) PMNT/IRCT/ESCT; 2) PMNT/IRCT/RRTN; 3) CAMT/ACCB/SWEP.

	<NbOfNtries>	15n	M	Number of debit entries. If there have been no transactions of the respective type on the reporting date, zero "0" is indicated.										
	<Sum>	18d EUR	M	Sum of debit entries. If there have been no transactions of the respective type on the reporting date, zero "0" is indicated.										
	<BkTxCd>	Set of elements	M	Set of elements used to fully identify the type of underlying transaction resulting in an entry.										
	<Domn>	Set of elements	M											
	<Cd>	4!a	M	Only following ISO 20022 codes are allowed <table border="1"> <thead> <tr> <th>Code</th> <th>Explanation</th> </tr> </thead> <tbody> <tr> <td>PMNT</td> <td>Instant payment (pacs.008) and instant payment return (pacs.004).</td> </tr> <tr> <td>CAMT</td> <td>Increase or decrease in the current IP liquidity position as a result of a liquidity transfer.</td> </tr> </tbody> </table>	Code	Explanation	PMNT	Instant payment (pacs.008) and instant payment return (pacs.004).	CAMT	Increase or decrease in the current IP liquidity position as a result of a liquidity transfer.				
Code	Explanation													
PMNT	Instant payment (pacs.008) and instant payment return (pacs.004).													
CAMT	Increase or decrease in the current IP liquidity position as a result of a liquidity transfer.													
	<Fmly>	Set of elements	M											
	<Cd>	4!a	M	Only following ISO 20022 codes are allowed. <table border="1"> <thead> <tr> <th>Code</th> <th>Explanation</th> </tr> </thead> <tbody> <tr> <td>RRCT</td> <td>Received instant payment (pacs.008) and instant payment return (pacs.004).</td> </tr> <tr> <td>IRCT</td> <td>Sent instant payment (pacs.008) and instant payment return (pacs.004).</td> </tr> <tr> <td>ACCB</td> <td>Increase or decrease in the current IP liquidity position as a result of a liquidity transfer.</td> </tr> </tbody> </table>	Code	Explanation	RRCT	Received instant payment (pacs.008) and instant payment return (pacs.004).	IRCT	Sent instant payment (pacs.008) and instant payment return (pacs.004).	ACCB	Increase or decrease in the current IP liquidity position as a result of a liquidity transfer.		
Code	Explanation													
RRCT	Received instant payment (pacs.008) and instant payment return (pacs.004).													
IRCT	Sent instant payment (pacs.008) and instant payment return (pacs.004).													
ACCB	Increase or decrease in the current IP liquidity position as a result of a liquidity transfer.													
	<SubFmly Cd>	4!a	M	Only following ISO 20022 codes are allowed. <table border="1"> <thead> <tr> <th>Code</th> <th>Explanation</th> </tr> </thead> <tbody> <tr> <td>ESCT</td> <td>Instant payment.</td> </tr> <tr> <td>RRTN</td> <td>Instant payment return.</td> </tr> <tr> <td>SWEP</td> <td>Decrease in the current IP liquidity position as a result of a liquidity transfer.</td> </tr> <tr> <td>TOPG</td> <td>Increase in the current IP liquidity position as a result of a liquidity transfer.</td> </tr> </tbody> </table>	Code	Explanation	ESCT	Instant payment.	RRTN	Instant payment return.	SWEP	Decrease in the current IP liquidity position as a result of a liquidity transfer.	TOPG	Increase in the current IP liquidity position as a result of a liquidity transfer.
Code	Explanation													
ESCT	Instant payment.													
RRTN	Instant payment return.													
SWEP	Decrease in the current IP liquidity position as a result of a liquidity transfer.													
TOPG	Increase in the current IP liquidity position as a result of a liquidity transfer.													
	<Ntry>	Set of elements	C	Set of elements used to specify an entry in the report.										
	<NtryRef>	35x	M	Entry reference.										
	<Amt>	18d EUR	M	Amount.										
	<CdtDbtInd>	4!a	M	Indicates whether the entry is a credit or a debit entry. Code "CRDT" is used to indicate a credit entry, code "DBIT" is used to indicate a debit entry.										
	<Sts>	Set of elements	M	Entry status.										
	<Cd>	4!a	M	Entry status code. Code "BOOK" is used.										

	<BookgDt>	Set of elements	M											
	<DtTm>	ISODateTime	M	Date and time when an entry is posted to an account.										
	<BkTxCd>	Set of elements	M	Set of elements used to identify the type of underlying transaction resulting in an entry.										
	<Domn>	Set of elements	M											
	<Cd>	4!a	M	Only following ISO 20022 codes are allowed <table border="1"> <thead> <tr> <th>Code</th> <th>Explanation</th> </tr> </thead> <tbody> <tr> <td>PMNT</td> <td>Instant payment (pacs.008) and instant payment return (pacs.004).</td> </tr> <tr> <td>CAMT</td> <td>Increase or decrease in the current IP liquidity position as a result of a liquidity transfer.</td> </tr> </tbody> </table>	Code	Explanation	PMNT	Instant payment (pacs.008) and instant payment return (pacs.004).	CAMT	Increase or decrease in the current IP liquidity position as a result of a liquidity transfer.				
Code	Explanation													
PMNT	Instant payment (pacs.008) and instant payment return (pacs.004).													
CAMT	Increase or decrease in the current IP liquidity position as a result of a liquidity transfer.													
	<Fmly>	Set of elements	M											
	<Cd>	4!a	M	Only following ISO 20022 codes are allowed. <table border="1"> <thead> <tr> <th>Code</th> <th>Explanation</th> </tr> </thead> <tbody> <tr> <td>RRCT</td> <td>Received instant payment (pacs.008) and instant payment return (pacs.004).</td> </tr> <tr> <td>IRCT</td> <td>Sent instant payment (pacs.008) and instant payment return (pacs.004).</td> </tr> <tr> <td>ACCB</td> <td>Increase or decrease in the current IP liquidity position as a result of a liquidity transfer.</td> </tr> </tbody> </table>	Code	Explanation	RRCT	Received instant payment (pacs.008) and instant payment return (pacs.004).	IRCT	Sent instant payment (pacs.008) and instant payment return (pacs.004).	ACCB	Increase or decrease in the current IP liquidity position as a result of a liquidity transfer.		
Code	Explanation													
RRCT	Received instant payment (pacs.008) and instant payment return (pacs.004).													
IRCT	Sent instant payment (pacs.008) and instant payment return (pacs.004).													
ACCB	Increase or decrease in the current IP liquidity position as a result of a liquidity transfer.													
	<SubFmlyCd>	4!a	M	Only following ISO 20022 codes are allowed. <table border="1"> <thead> <tr> <th>Code</th> <th>Explanation</th> </tr> </thead> <tbody> <tr> <td>ESCT</td> <td>Instant payment.</td> </tr> <tr> <td>RRTN</td> <td>Instant payment return.</td> </tr> <tr> <td>SWEP</td> <td>Decrease in the current IP liquidity position as a result of a liquidity transfer.</td> </tr> <tr> <td>TOPG</td> <td>Increase in the current IP liquidity position as a result of a liquidity transfer.</td> </tr> </tbody> </table>	Code	Explanation	ESCT	Instant payment.	RRTN	Instant payment return.	SWEP	Decrease in the current IP liquidity position as a result of a liquidity transfer.	TOPG	Increase in the current IP liquidity position as a result of a liquidity transfer.
Code	Explanation													
ESCT	Instant payment.													
RRTN	Instant payment return.													
SWEP	Decrease in the current IP liquidity position as a result of a liquidity transfer.													
TOPG	Increase in the current IP liquidity position as a result of a liquidity transfer.													
	<NtryDtls>	Set of elements	M	Set of elements used to provide details on the entry.										
	<TxDtls>	Set of elements	M											
	<RltdAgts>	Set of elements	M											
	<DbtrAgt>	Set of elements	M	Debtor agent.										
	<FinInstn Id>	Set of elements	M											
	<BICFI>	4!c2!a2!c[3!c]	M	BIC of the debtor agent.										
	<CdtrAgt>	Set of elements	M	Creditor agent.										
	<FinInstn Id>	Set of elements	M											
	<BICFI>	4!c2!a2!c[3!c]	M	BIC of the creditor agent.										

└─	<RltdDts>	Set of elements	C	Used when <Domn>/<Cd> contains code "PMNT".
└─	<Acptnc DtTm>	ISODateTime	C	Used when <SubFmlyCd> contains code "ESCT".
└─	<IntrBk SttlmDt>	ISODate	C	Used when <SubFmlyCd> contains code "RRTN".